

University of Arkansas, Fayetteville

ScholarWorks@UARK

Chemical Engineering Undergraduate Honors
Theses

Chemical Engineering

12-2016

Chlorpyrifos Removal for Wastewater Reuse

Indran Kamalanathan

University of Arkansas, Fayetteville

Follow this and additional works at: <https://scholarworks.uark.edu/cheguht>



Part of the [Environmental Engineering Commons](#), and the [Other Chemical Engineering Commons](#)

Citation

Kamalanathan, I. (2016). Chlorpyrifos Removal for Wastewater Reuse. *Chemical Engineering Undergraduate Honors Theses* Retrieved from <https://scholarworks.uark.edu/cheguht/94>

This Thesis is brought to you for free and open access by the Chemical Engineering at ScholarWorks@UARK. It has been accepted for inclusion in Chemical Engineering Undergraduate Honors Theses by an authorized administrator of ScholarWorks@UARK. For more information, please contact scholar@uark.edu, uarepos@uark.edu.

Chlorpyrifos Removal for Wastewater Reuse

Bachelor of Science in Chemical Engineering

Indran Kamalanathan

December, 2016

University of Arkansas

Advisor Signature:

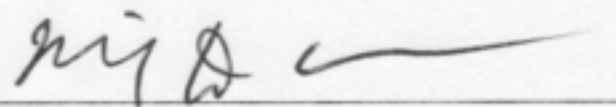

Dr. Michael Ackerson

Committee Member/First Reader

Signature:

Committee Member/Second Reader

Signature:

Committee Member Signature:

As part of the WERC 2016 Wastewater Reuse team I worked alongside other team members on several tasks including determining potential treatment, reuse, and chemical options, organizing a trip to New Mexico to collect wastewater samples and research wastewater systems, developing an analytical method for a chosen chemical contaminant, and presenting our findings at the WERC competition.

The first element of the project was determination of a potential treatment and reuse option based on the prompt of utilizing tertiary treatment of a 144,000 gpd wastewater source. Through research and past experiences, I suggested options for tertiary treatment including an ozonation process, carbon adsorption, reverse osmosis, and constructed wetlands. These were all evaluated and a combination of carbon adsorption and ozonation along with UV treatment was utilized in the final design. The other aspect of the design was evaluating potential reuse options. I determined the regulations in New Mexico regarding reuse water and worked to find reuse implementations that would be allowed by the state. Through this process, I contacted a wastewater treatment plant in Rio Rancho, NM that was undergoing implementation of a reuse system and working with the state government to approve indirect potable water reuse. The findings from this investigation and the information gained from contacting the treatment plant in Rio Rancho were utilized to decide upon the suggested reuse options in the final paper. The other major preliminary aspect of the research was to determine a chemical contaminant to analyze. The chosen chemical needed to be representative of the emerging contaminants that make water reuse difficult and applicable to our chosen site in New Mexico. I studied at a variety of options and determine toxicity levels in humans and the environment for each chemical. This led to our team deciding on chlorpyrifos for the focus of our paper.

During the initial research phase of the project, I worked to find several potential sites that were appropriate for a tertiary wastewater system of the scale designated by the project. I contacted these sites and organized a visit for the team to observe the existing treatment system. This allowed us to connect with the supervision at these sites to determine their willingness to develop a tertiary system. I was also able to organize a meeting with the supervision at Rio Rancho, NM to tour their facility and determine the challenges they have faced from regulation and the community in implementation of a reuse system. These findings were important as they

helped guide our site and implementation choices in the final project. These contacts were also vital as reviewers for our paper and continued support throughout the project.

The primary technical aspect of my involvement in the WERC team was development of the analytical method for our chosen chemical. Testing began utilizing caffeine as a general indicator for the effectiveness of the system. This analyte was chosen as caffeine had a known analytical HPLC method and was known to be treatable by our chosen tertiary system. The challenge was to then modify the HPLC method for caffeine detection to allow for detection of chlorpyrifos. I was involved in varying the HPLC solvents, peak wavelength, injection volumes, and run times to allow for the optimal sensitivity for chlorpyrifos. Along with direct optimization of the method, the samples produced by the system had to be further concentrated for detection. I helped to analyze liquid-liquid extraction, rotary evaporation, and lyophilization of the sample to further concentrate the results. The other key problem was dissolving the powdered chlorpyrifos into the 15 L tested sample. This involved determining organic solvents to dissolve the chlorpyrifos into the tested sample that would not interact with the treatment or analytical method. Proper development of the analytical techniques was key for the success of our project.

The final aspect of my project was to present the material. After helping to write and edit the paper, I was chosen by the team to present the background of the project including the chemical toxicity, comparisons to other treatment methods, and the water reuse options. This involved a formal presentation to the judges as well as informal poster session discussions. The apparatus also had to be run on site and I assisted in the safety and sample preparation required for running our apparatus. This required collaboration with the staff and with other researchers at the competition who were responsible for the analysis of our wastewater project.

Wastewater Reuse

WERC 2016

TASK # 3

WOO-PIG-SEWAGE



Ralph E. Martin Department of Chemical Engineering
University of Arkansas

Wastewater Reuse

WERC 2016

Task #3

March 18, 2016

Woo-Pig-Sewage

Zach Bare

Indran Kamalanathan

Mikala Parton

Dustin Resz

Kaylee Smith

Holly Wilder

Faculty Advisor: Dr. Michael Ackerson

Dr. W. Roy Penney

Faculty Mentors: Dr. Tammy Lutz-Rechtin

Ralph E. Martin Department of Chemical Engineering

University of Arkansas

Fayetteville, AR

Table of Contents

| | |
|--|-----------|
| 1.0 EXECUTIVE SUMMARY | 3 |
| 2.0 PURPOSE | 4 |
| 3.0 TERTIARY WASTEWATER TREATMENT METHODS..... | 5 |
| 3.1 Adsorption | 5 |
| 3.2 Advanced Oxidation Processes | 6 |
| 3.3 Filtration | 6 |
| 3.4 Distillation..... | 7 |
| 3.5 Reverse Osmosis..... | 7 |
| 4.0 TASK PREMISE | 7 |
| 5.0 ANALYTICAL TESTING..... | 8 |
| 5.1 Chemicals and Instrumentation | 8 |
| 5.2 Methods..... | 8 |
| 5.3 Sample Preparation | 8 |
| 5.4 Concentration Curves..... | 9 |
| 6.0 DESIGN BASIS..... | 9 |
| 6.1 Contaminants | 9 |
| 6.2 Sand Filtration | 9 |
| 6.3 Advanced Oxidation Process (O₃/UV) | 10 |
| 6.3.1 Chlorpyrifos Degradation Products | 10 |
| 6.4 Carbon Filtration | 10 |
| 7.0 BENCH SCALE DESIGN..... | 11 |
| 7.1 Experimental Apparatus | 11 |
| 7.2 Bench Scale Procedure | 12 |
| 7.3 Process Flow Diagram | 13 |
| 8.0 EXPERIMENTAL RESULTS AND DISCUSSION..... | 13 |
| 8.1 Caffeine Data..... | 13 |
| 8.2 Chlorpyrifos Data | 14 |
| 8.3 Results & Discussion..... | 15 |
| 9.0 INDUSTRIAL SCALE DESIGN..... | 16 |
| 9.1 Sand Filtration Scale –Up | 16 |
| 9.2 Oxidation Scale-Up | 16 |
| 9.3 Ultraviolet Scale-Up..... | 16 |
| 9.4 Activated Carbon Filtration Scale-Up | 16 |
| 9.5 Process and Equipment Description | 17 |
| 9.6 Intended Water Reuse | 17 |
| 10.0 ECONOMIC ANALYSIS | 18 |
| 11.0 SAFETY AND ENVIRONMENTAL..... | 21 |
| Caffeine..... | 21 |
| Chlorpyrifos | 21 |

Ozone 21

12.0 CONCLUSIONS AND RECOMMENDATIONS..... 21

13.0 ACKNOWLEDGEMENTS 22

14.0 REFERENCES..... 22

1.0 EXECUTIVE SUMMARY

Approximately 1.2 billion people around the world live in areas of physical water scarcity. This could increase to half of the world's population by 2030 and could displace 24 to 700 million people unless steps are taken to ensure adequate water supply.¹ Water scarcity is an escalating issue within the United States, specifically in Western inland states with arid climates. This scarcity is encouraging communities to investigate tertiary level municipal wastewater treatment, allowing for reuse of wastewater. Unfortunately, wastewater contains numerous contaminants that are not regulated by the Environmental Protection Agency (EPA) under the Safe Drinking Water Act (SDWA). Many of these contaminants are endocrine disrupting compounds (EDCs). According to the European Union Commission, an endocrine disruptor is “an exogenous substance that causes adverse health effects in an intact organism, or its progeny, in consequence to the induced changes in endocrine functions.”² Many EDCs are not completely removed by standard secondary wastewater treatment methods. With the growing demand for potable water, as well as water for irrigation and agricultural purposes, communities are having to evaluate the potential health risks due to EDCs and other unregulated compounds.

The Woo-Pig-Sewage team selected one unregulated contaminant, chlorpyrifos (CLP), to test. CLP is an organophosphate insecticide that is commonly used residentially and commercially. CLP has a long term impact as a cholinesterase inhibitor in humans.³ Using traditional biological methods, CLP, as well as other pesticides, are nearly impossible to remove.⁴ CLP is on the Fourth Unregulated Contaminant Monitoring Rule list produced by the EPA to provide a basis for future regulation.⁵ A bench scale unit utilizing ozone treatment (O₃), ultraviolet radiation (UV), and granular activated carbon (GAC) was constructed to remove this contaminant from doped nanopure water. Ultimately, the selected technologies will be able to treat secondary wastewater effluent from the wastewater treatment plant (WWTP) in Tucumcari, New Mexico for direct or indirect aquifer reintroduction. Direct aquifer reintroduction would involve injection of water to the existing aquifer, while indirect aquifer introduction would consist of introducing treated effluent to an existing canal system.

An oxidation process paired with UV and GAC filtration can be utilized to remove EDCs such as CLP and other unregulated contaminants from wastewater. O₃ is extremely effective at oxidizing bacteria as well as other organic molecules. UV is also a commonly used method to degrade organic compounds and is currently being used at the WWTP in Tucumcari, New

Mexico and in Fayetteville, Arkansas. GAC is utilized to remove trace amounts of contaminants from wastewater streams, usually as a final treatment before the water is reintroduced to the environment. The WWTP in Rio Rancho, New Mexico currently plans to utilize GAC filtration in this manner.

The Woo-Pig-Sewage team performed experiments to determine if the combination of O₃, UV, and GAC could reduce CLP to a concentration below the minimum detection limit of 0.001 ppm. To test the effectiveness of the bench scale, caffeine was used as an organic tracer. Bench scale results indicate that the proposed system is effective in the removal of caffeine and CLP from doped water samples. Caffeine concentrations were reduced to below the minimum detection limit of 0.05 ppm for samples with initial concentrations ranging from 0.1 ppm to 10 ppm. CLP was reduced to below the minimum detection limit of 0.001 ppm from an initial concentration of 0.1 ppm.

An industrial scale process was sized based on treating secondary effluent from the WWTP in Tucumcari, NM. The total cost was determined to be an additional \$2.31 per 1000 gallons, assuming 0% grant funding and a 6% commercial loan. This estimate brings the total cost to \$4.95 per 1000 gallons for the existing treatment paired with the proposed system. While this adds a significant cost to the existing treatment at the WWTP in Tucumcari, plants with larger flow rates would see significantly less of an increase in the total cost per 1000 gallons. This can be seen from the comparison of the 144,000 gallon per day (gpd) system with existing UV treatment and the 300,000 gpd Tucumcari system also utilizing UV treatment. The 144,000 gpd system was estimated to cost about 60% more per 1000 gallons. However, if the Tucumcari WWTP is awarded a grant to cover 100% of the Fixed Capital Investment (FCI), the proposed system would only increase the cost per 1000 gallons by 38%. If the EPA determines that EDCs such as CLP must be removed from the effluent of WWTPs, a process such as the one proposed by the Woo-Pig-Sewage team will be necessary.

2.0 PURPOSE

One major issue that has arisen as the result of a continually evolving global condition is water scarcity. Water scarcity is the lack of access to acceptable quantities of water and is defined as a decrease in annual water supply to a quantity below 1,000 m³/person.¹ With limited availability of freshwater resources, the world's growing population is putting an abundance of

stress on water resources and causing a demand for new water treatment technologies. This is prompting communities to look at municipal wastewater to be treated for reuse. The problem with municipal wastewater is that it contains numerous contaminants that are not regulated by the EPA under the SDWA. This is causing communities to evaluate potential health risks and seek out available technologies to treat municipal wastewater. There are numerous chemical and mechanical systems that are used for tertiary wastewater treatment that vary in cost, separation efficiency, and robustness.⁶ One way to alleviate the potential health and environmental risks associated with wastewater reuse is to remove EDCs from municipal wastewater.

3.0 TERTIARY WASTEWATER TREATMENT METHODS

Tertiary treatment is required to remove emerging contaminants, such as those found on the EPA Third and Fourth Unregulated Contaminant Monitoring Rule lists.⁵ Tertiary treatment is defined as any treatment beyond secondary and includes adsorption, advanced oxidation, UV, filtration, reverse osmosis (RO), or any combination of these methods.

3.1 Adsorption

A wide range of adsorbents are used in wastewater treatment to remove heavy metals and dissolved organic compounds, as well as reduce chemical oxygen demand (COD), biological oxygen demand (BOD), and regulate color. The adsorption media can be granular or powdered. Typical media includes activated carbon, clays, magnesium oxide, ferric oxide, and saw dust.⁷ Adsorption normally occurs by two processes: physical and chemical adsorption. While chemical adsorption involves the transfer or sharing of electrons, physical adsorption is a surface process, making surface area a key parameter of adsorbents. Adsorbents are highly porous materials with surface areas that range between 100 and 1000 m²/g.⁸ The extent of adsorption is usually proportional to the surface area. For wastewater treatment adsorption processes have been found to be less complex in terms of operation and design; these systems also tend to be insensitive to toxic substances.⁹ A GAC system was chosen by the Woo-Pig-Sewage team as a treatment method due to its ability to remove a variety of organic compounds, including insecticides such as CLP.^{10,11}

3.2 Advanced Oxidation Processes

Advanced oxidation processes (AOPs) typically consist of some combination of hydrogen peroxide (H_2O_2), O_3 , and/or UV treatment. H_2O_2 is a powerful oxidizer and reacts with an array of substances. However, H_2O_2 has a lower oxidation potential than O_3 and requires the continuous supply of chemicals, whereas O_3 can be generated on site.¹² H_2O_2 is considered a hazardous chemical which requires secondary containment, security and handling precautions, as well as special operator training.¹³ One disadvantage of H_2O_2 is that under certain conditions, such as high temperature, H_2O_2 can rapidly decompose into hydrogen and oxygen.¹⁴ H_2O_2 can also be combined with O_3 and UV treatment. Although H_2O_2 and O_3 combined with UV is excellent at removing COD and BOD contributing compounds, the cost is greater than the combination of O_3 and UV.¹⁵ Studies have shown that the addition of H_2O_2 with O_3 proved to be only slightly more effective in the removal of EDCs than O_3 alone.¹⁶ For this reason, as well as the hazards of on-site chemical storage, H_2O_2 treatment was not considered as an addition to the proposed treatment system.

3.3 Filtration

There are currently many different types of filtration used in wastewater treatment. The most commonly used types of filtration are sand filtration, microfiltration, and ultrafiltration. Sand filters are often used immediately following conventional activated sludge systems to decrease turbidity. A typical sand filter is a down-flow packed bed filtration system and meets the EPA requirement for 80% reduction of TSS.¹⁷ Sand filtration is also inexpensive compared to other filtration methods.¹⁸ For these reasons, the Woo-Pig-Sewage team has included sand filtration treatment in the industrial scale design.

Microfiltration and ultrafiltration are similar in design and function but remove different sized particles. Microfiltration removes particles above $0.1 \mu\text{m}$ in size, while ultra-filtration removes particles as small as $0.01 \mu\text{m}$. Ultrafiltration is typically preceded by microfiltration. Both types of filtration utilize backwash systems to reduce fouling and to extend the life of the membranes.¹⁹ Microfiltration paired with ultrafiltration may not be adequate to remove EDCs as a stand-alone system. These systems are very prone to fouling when treating influent wastewater with high amounts of suspended solids. For this reason, upkeep is tedious and is required often, making microfiltration paired with ultrafiltration an expensive treatment method. Due to cost of operation and upkeep, microfiltration and ultrafiltration were not considered.

3.4 Distillation

Although distillation is typically successful in removing most of the dissolved material, it is energy intensive and has a difficult time removing volatile and semi-volatile chemicals. These volatile chemicals have a boiling point around or below the boiling point of water and will be eluted in the distillate stream, requiring further separation. Not only is distillation energy intensive, it is also expensive to install and operate a column large enough to handle the flow rates typically seen in WWTPs. Given the large energy requirement, the possibility of distillate contamination, and the additional cost required to install and operate a distillation column, distillation was omitted from the potential treatment options.

3.5 Reverse Osmosis

RO has been proven to be an effective method for removing contaminants from wastewater. However, water that is to be treated by RO requires a significant amount of pre-filtration, including sand, micro, ultra, and possibly nanofiltration. Operation of a pre-filtration train for RO is expensive due to constant fouling and filter replacements. RO also produces a concentrated retentate stream, which must be further treated to prevent environmental contamination. An AOP used to degrade resilient compounds followed by GAC has been suggested as a promising process combination over RO because of lower waste production and greater water recovery.²⁰ For these reasons, RO was not considered as a treatment method.

4.0 TASK PREMISE

The purpose of this task is to investigate treatment methods for municipal wastewater and design a system that could efficiently and economically remove EDCs from a contaminated waste stream intended for reuse.

The considerations for this task are as follows:⁶

- Design and test a working prototype that is able to process five to ten liters of a water solution with the contaminants
- Define system operating parameters
- Address health and safety issues
- Provide process details including chemical reactions that occur
- Demonstrate the process efficacy through the bench-scale apparatus
- Evaluate costs and application feasibility

- Compare the proposed advanced oxidation/adsorption combination to other methods for removing specific contaminants
- Demonstrate economics and functionality

5.0 ANALYTICAL TESTING

The EPA official testing methods for most EDCs are either liquid chromatography-mass spectroscopy (LC-MS) or gas chromatography-mass spectroscopy (GC-MS). Caffeine is often the standard for both types of instrumentation. The standard testing method used for CLP is EPA method 525.3, which utilizes GC-MS.⁵ As the samples for this experiment are doped nanopure water, MS was deemed unnecessary. High performance liquid chromatography (HPLC) was chosen as an alternative to GC-MS due to the cost of testing, quantity of samples, and previous experience with HPLC.

5.1 Chemicals and Instrumentation

Analytical testing was conducted using a 2.1mm by 150 mm C-18 HPLC column with a 5 μm pore size and an ultraviolet light detector. A rotary evaporator was used to concentrate the CLP samples before HPLC testing. These tests were conducted using caffeine with a purity of 99.9% and CLP with a purity of 99.7%

5.2 Methods

A method was developed for both contaminants based on published methods and previous experience. The solvents chosen were an acetonitrile solution with 0.1% trifluoroacetic acid in conjunction with a water solution with 0.1% trifluoroacetic acid. An injection volume of 50 μL was used for caffeine and 90 μL for CLP. A 206 nm wavelength was used to analyze the results because both compounds have a maximum absorbance peak near this wavelength. Caffeine was analyzed using a 5 to 95% acetonitrile gradient and CLP was analyzed using 80% isocratic acetonitrile.

5.3 Sample Preparation

Caffeine samples were taken directly from the bench scale and analyzed using the HPLC. CLP samples were dried using a rotary evaporator then suspended in an 80% acetonitrile and 20% water solution. Concentrating the samples produced more distinct HPLC peaks and lowered the detection limit.

5.4 Concentration Curves

Concentration curves were prepared using the same HPLC methods as the sample preparation except CLP was directly suspended in 80% acetonitrile instead of being concentrated using rotary evaporation. Excel was used to determine the linear relationship for concentration (C) based on the area (A) under the HPLC curves shown in Table 1 below.

Table 1: Concentration Curves

| Contaminant | Concentration Curve | R ² |
|--------------|---|----------------|
| Caffeine | $C_{(PPM)} = 0.138 * A_{(UV*sec)} * 10^{-6} - 0.0677$ | 0.999 |
| Chlorpyrifos | $C_{(PPM)} = 12.9 * A_{(UV*sec)} * 10^{-6} - 0.297$ | 0.999 |

6.0 DESIGN BASIS

6.1 Contaminants

Caffeine and CLP were selected as contaminants for testing. Caffeine was selected to test our analytical capabilities as well as our bench scale design. CLP was chosen as a contaminant because of its toxicity and the limited amount of literature available about its degradation and removal by oxidation.²¹

Caffeine testing was conducted with an initial concentration of 0.1 ppm based on typical wastewater influent concentrations in Rio Rancho, New Mexico. Other concentrations were tested as well to determine the efficacy and robustness of the bench scale design. Typical wastewater influent concentrations of CLP range from 30 ppt to 176 ppt.²² However, CLP testing was done with an initial concentration of 0.1 ppm to allow for analytical method detection.

6.2 Sand Filtration

Rapid sand filtration after sedimentation is a common practice used worldwide. The purpose for using sand filtration as a pretreatment to our proposed AOP is to reduce the turbidity of the secondary wastewater stream. The reduction in turbidity will reduce the magnitude of hydroxyl scavengers for the oxidation process and allow for greater UV transmittance as well as prevent larger particles from clogging the GAC filters. Sand filtration was chosen because of its relatively low cost, operation, and maintenance requirements.¹⁸ Typical filtration rates for are 3 m/hr to 15 m/hr, while 5 m/hr is used in conventional rapid sand filtration systems.¹⁸ Coarse 0.5mm to 1.0mm media and a filter media depth of 0.5m to 1.0 m are most commonly used.^{18, 23}

6.3 Advanced Oxidation Process (O₃/UV)

O₃ was chosen as a treatment system because it is highly effective at destroying pathogens and shows significant removal of resilient compounds (38%) compared to ultrafiltration (0%).¹⁶ Removal of caffeine by O₃ oxidation has been proven to be greater than 80%.¹⁶ O₃ is advantageous because it has no harmful residuals due to fast decomposition and produces elevated dissolved oxygen concentration in effluent.²⁴ However, because O₃ is highly reactive and corrosive, corrosive-resistant material is required. It is also an irritant and toxic. O₃ units have a high capital cost and are power intensive but do not require transport or storage of chemicals.²⁴ O₃ and UV in tandem provide a synergistic effect in wastewater treatment. O₃ increases the transmittance of UV in waters, while UV provides the necessary energy to spark the formation of hydroxyl radicals.^{25, 26} The synergies of O₃ and UV lead to a decrease in overall unit size which result in a reduction in capital, operating, and maintenance costs.²⁶

6.3.1 Chlorpyrifos Degradation Products

CLP, when reacted with O₃, is broken down into two main degradation products: chlorpyrifos oxon and trichloropyrinidol. Chlorpyrifos oxon is the most toxic metabolite of CLP and is a strong EDC due to an active phosphate group on the molecule. CLP and chlorpyrifos oxon both act as inhibitors for cholinesterase, a key enzyme required for nerve function.²⁷

6.4 Carbon Filtration

GAC was chosen as a final treatment stage to adsorb degradation products produced by O₃ and UV, including chlorpyrifos oxon and trichloropyrinidol. GAC has been proven to remove a plethora of organic compounds such as pesticides, herbicides, aromatic solvents, polynuclear aromatics, phenolics and chlorinated solvents from industrial and municipal wastewater.^{10, 11} O₃, as a pretreatment for GAC, has been proven to enhance the biological activity on the GAC particles, which leads to a reduction in dissolved organic carbon and allows O₃ by-products to be consumed by bacteria. Studies have also shown that O₃ and GAC in tandem can drastically improve the lifetime of a GAC filter.²⁸

7.0 BENCH SCALE DESIGN

The bench scale apparatus consists of three individual batch processes. These processes are as follows: an O₃ unit, a UV unit, and a GAC filtration system. Doped nanopure water is charged into the O₃ contact vessel. A positive displacement pump draws water out of the O₃ contact vessel and pumps it through a static mixer where five mg/min of O₃ is introduced. The water becomes saturated with O₃ in the static mixer and is reintroduced to the O₃ contact vessel. This continues until the required time for the desired dosage has been met. Once the required dosage is met, the recirculation pump, the air pump, and the O₃ generator are turned off.

Upon completion of O₃ treatment, a submersible pump inside the O₃ contact vessel is turned on. This pump transfers water through a UV chamber. The flow through the chamber is fixed so that a 54 mJ/cm² dose is achieved. Effluent from the UV chamber flows into a holding vessel for the GAC filter.

When the level of water in the O₃ contact chamber reaches the inlet of the submersible pump, the submersible pump is turned off and the UV lamp is powered down. The final pump for the GAC system is then turned on. This pump draws water from the GAC holding vessel and forces it through the carbon filter. The flow rate through the filter is fixed so that a 5.6-minute empty bed contact time is achieved. The effluent from the GAC filter flows through a guard filter before entering the final collection vessel.

7.1 Experimental Apparatus

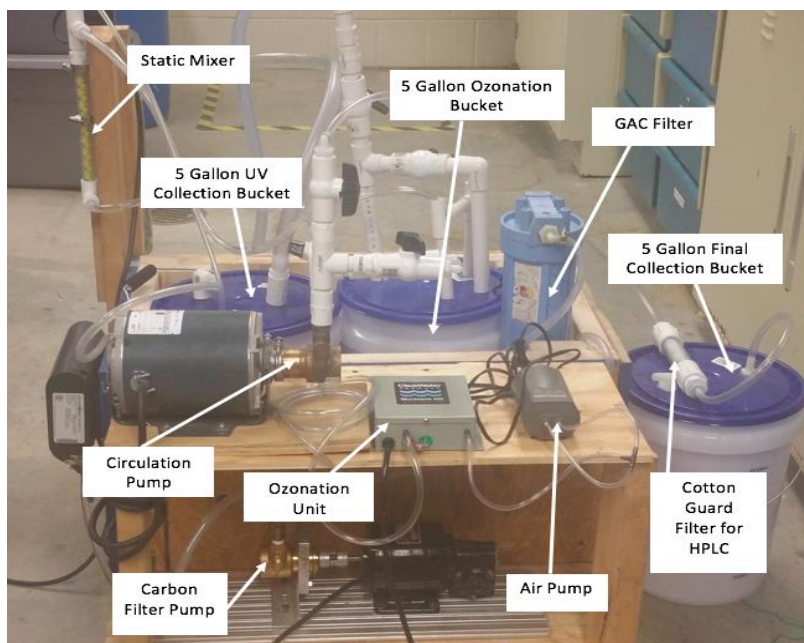

Figure 1: A view from the front of the bench scale apparatus.

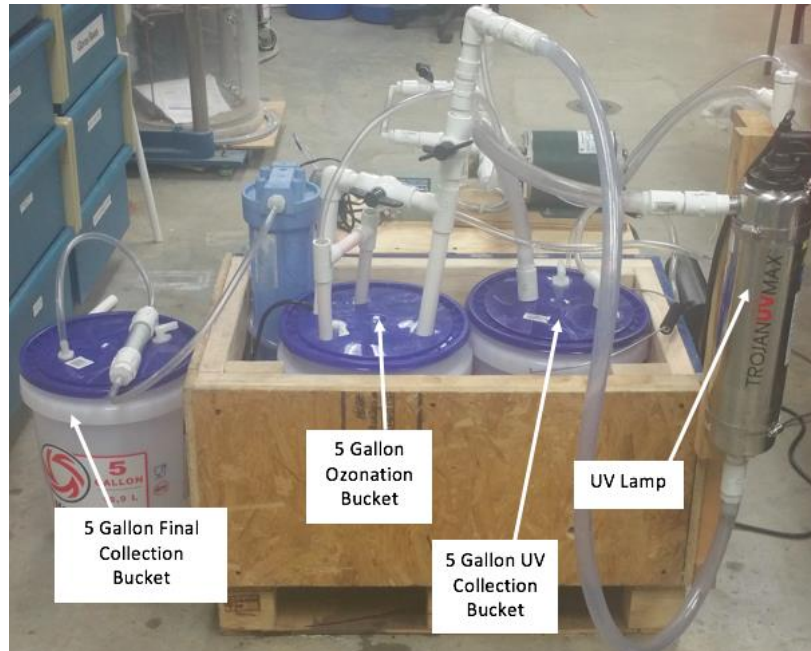

Figure 2: A view from the back side of the experimental apparatus.

7.2 Bench Scale Procedure

1. Fill feed vessel T-0001 with 15 liters of doped water sample
2. Turn on UV light UV-0001
3. Turn on pump P-0002 to static mixer M-0001 (begin mixing sample)
4. Turn on air pump P-0001
5. Turn on ozone generator OZ-0001 and start stopwatch
6. At desired time for ozone dose of 5mg/L, turn off ozone generator OZ-0001
7. Turn off air pump P-0001
8. Turn off pump P-0002
9. Turn on pump P-0003 to UV element UV-0001
10. Turn off pump P-0003 to UV element UV-0001 when liquid level in O₃ contact vessel T-0001 falls to the level of P-0003 inlet
11. Turn on pump P-0004 to GAC filter bank F-0001
12. Turn off pump P-0004 when liquid level in UV collection vessel T-0002 falls to 1L

7.3 Process Flow Diagram

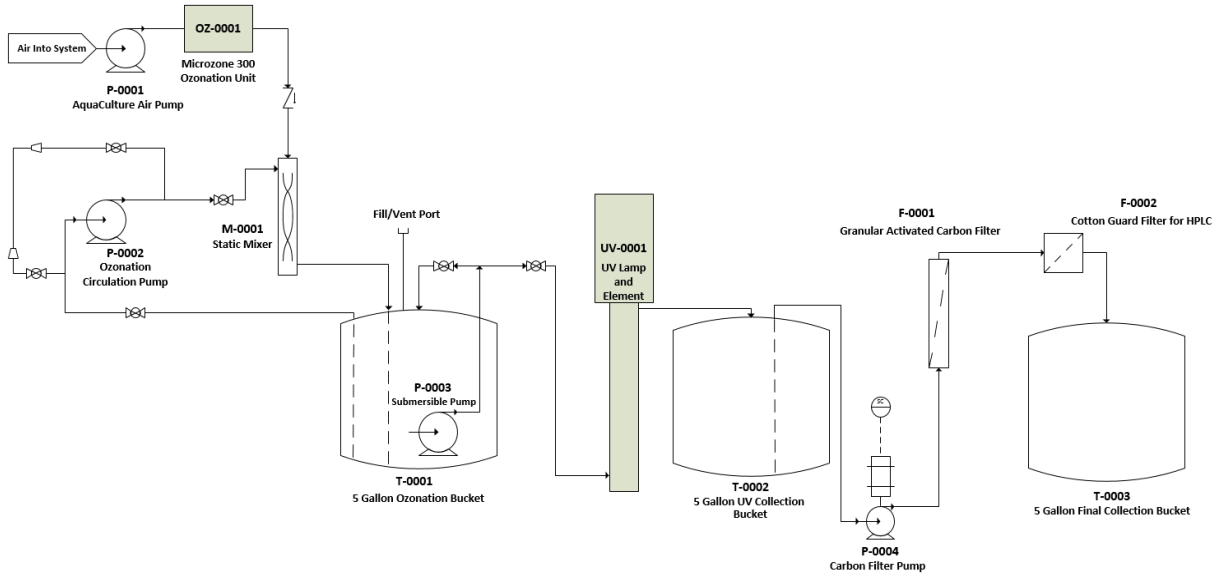

Figure 3: Process flow diagram for the bench scale apparatus

8.0 EXPERIMENTAL RESULTS AND DISCUSSION

8.1 Caffeine Data

Five experimental caffeine trials were tested in the bench scale design. The concentrations of trials one through five are 0.190 ppm, 0.100 ppm, and 9.951 ppm, 0.969 ppm, and 0.975 ppm, respectively. The summary of these tests and the results are shown in Table 2 below.

Table 2: Caffeine Results

| Trial Number | Stock Solution concentration (ppm) | Ozone Dose (mg/L) | Concentration after Ozone (ppm) | Concentration after UV (ppm) | Concentration after GAC (ppm) |
|--------------|------------------------------------|-------------------|---------------------------------|------------------------------|-------------------------------|
| 1 | 0.190 | 1.5 | 0.046* | 0.184 | - |
| 1 | 0.190 | 4 | 0.005* | - | - |
| 1 | 0.190 | 5 | 0.003* | - | - |
| 2 | 0.100 | 5 | 0.001* | 0.001* | - |
| 3 | 9.951 | 5 | 7.813 | 7.888 | 0.00341* |
| 4 | 0.969 | 5 | 0.100 | 0.116 | 0.020* |
| 5 | 0.975 | - | - | 0.971 | 0* |

*below detection limit of 0.050 ppm

8.2 Chlorpyrifos Data

An experimental trial of CLP was conducted at a concentration of 0.1 ppm. These samples were concentrated and the results are shown in Figures 4 and 5 below. The results of the trial after accounting for the concentration method are shown in Table 3 below.

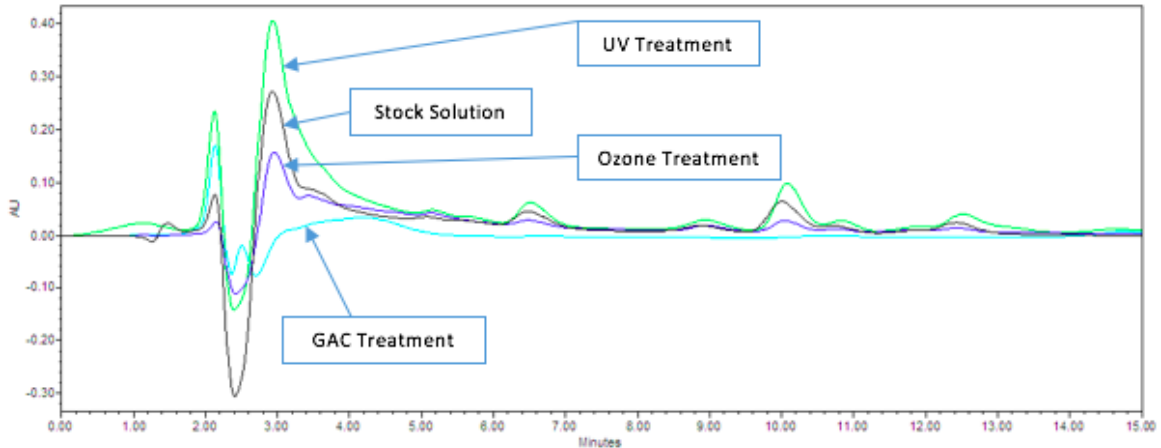

Figure 4: HPLC peaks after various stages of the bench scale treatment

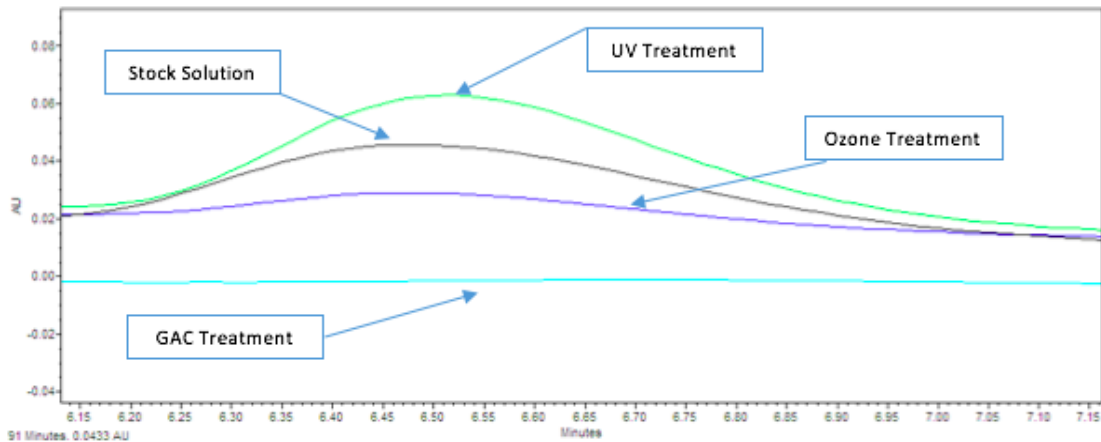

Figure 5: CLP Peaks at Various stages of bench scale treatment

Table 3: Concentrations based on CLP Concentration Curve

| Sampled Solution | Concentration of sample (ppm) |
|------------------|-------------------------------|
| Stock Solution | 0.093 |
| Ozone (5mg/L) | 0.084 |
| UV | 0.109 |
| GAC | 0* |

*below detection limit of 0.001 ppm

8.3 Results & Discussion

Caffeine was tested at a number of concentrations to demonstrate the effectiveness of the proposed system. The case most resembling a WWTP influent is trial 2 at a concentration of 0.1 ppm caffeine. In trial 2, the O₃ dose of 5 mg/L was effective to reduce the concentration of caffeine to approximately 0.003 ppm, which is below the detection limit of 0.050 ppm for the caffeine analytical method. Trial 3, which is the high concentration caffeine trial (10 ppm), demonstrates the limitations of the O₃ system at high concentrations. Trial 4 results indicate an 89.7% reduction due to O₃ treatment at an influent caffeine concentration of approximately 1ppm. Trials 1 and 5 indicate that UV treatment did not remove caffeine from the system on its own. Trials 2 and 4 also indicate UV treatment provided limited contaminant removal in conjunction with O₃. Trials 3, 4, and 5 all show the effectiveness of the GAC system at catching residual contaminants that escaped O₃ treatment, reducing the concentration down below detectable limits in all cases.

CLP was tested at a concentration of 0.1 ppm. The O₃ dose of 5 mg/L and the UV treatment caused a slight decrease and increase in the contaminant level, respectively. These differences are small enough to be accounted for by the error introduced in the rotary evaporation method. The data obtained from the samples collected after the O₃ and UV treatment was inconclusive. The GAC treatment was able to reduce the CLP concentration below the detection limit of 0.001 ppm.

In addition, there were a number of unidentified contaminants also picked up in the CLP trial. These contaminants are likely CLP degradation products that were present in the stock solution. These showed similar trends with varying concentrations after the O₃ and UV treatment, also indicating that the rotary evaporation method may have introduced error into the concentration reading. The GAC treatment was also able to reduce the concentrations of the unknown contaminants from the sample. This demonstrates the ability of the system to cope with varying contaminants beyond its intended design. The O₃ treatment has a varying effect across contaminants based on their individual reactivity, however the GAC treatment is effective at adsorbing organic contaminants.

9.0 INDUSTRIAL SCALE DESIGN

Two influent flow rates, 144,000 gpd and 300,000 gpd, were chosen to scale up the proposed treatment process. The flow rate of 144,000 gpd was selected to meet the requirements of the WERC wastewater reuse prompt; the 300,000 gpd flow rate was chosen because it is the projected average influent flow rate to Tucumcari's WWTP.

9.1 Sand Filtration Scale –Up

Rapid sand filtration in three deep-bed media filters was chosen as the sand filtration system. The chosen sand filter is a down flow filter. Two filter are in continuous operation with one on standby after completion of the backwash cycle. The water used for the backwash will be taken from an evaporative storage pond filled with the system effluent. This pond is already present at the Tucumcari WWTP. The backwash stream from the sand filters will be directed to the activated sludge basin.

9.2 Oxidation Scale-Up

An ozone skid unit was chosen as the O₃ system. The chosen skid unit includes an O₃ generator, static mixer, a venturi-type O₃ injection system, and automated controls. The chosen O₃ generators for the two systems produce 113 and 235 g/hr, which correspond to a dose of 5mg/L at flow rates of 144,000 and 300,000 gpd, respectively.

9.3 Ultraviolet Scale-Up

The existing WWTP at Tucumcari, NM utilizes an open channel UV system located in a detached building. Since O₃ is proposed to be injected prior to UV treatment, a significant vent will need to be constructed in the building to reduce the concentration of O₃ and off gasses released from the open channel. The proposed design for WWTPs with only secondary treatment would utilize a closed-vessel UV system so that significant venting is not necessary. The UV system was sized with an assumed low water transmittance of 50% and a UV dose of 60 mJ/cm².

9.4 Activated Carbon Filtration Scale-Up

The GAC filtration system was scaled up to be similar to the system currently utilized by the Rio Rancho, NM WWTP. The filtration system chosen consists of two vessels; each vessel contains 6000 lbs of virgin GAC. This system utilizes an empty bed contact time of 25 and 12.7 minutes for flow rates of 144,000 and 300,000 gpd, respectively. This is within the range of typical wastewater treatment systems, which have an empty bed contact times of 5 to 25 minutes depending on the magnitude and type of contaminants present.²⁹ The GAC filtration system

chosen also has the potential for backwash; the backwash stream will be directed back to the sand filters. The water used for the backwash will be the same water used for the sand filter backwash.

9.5 Process and Equipment Description

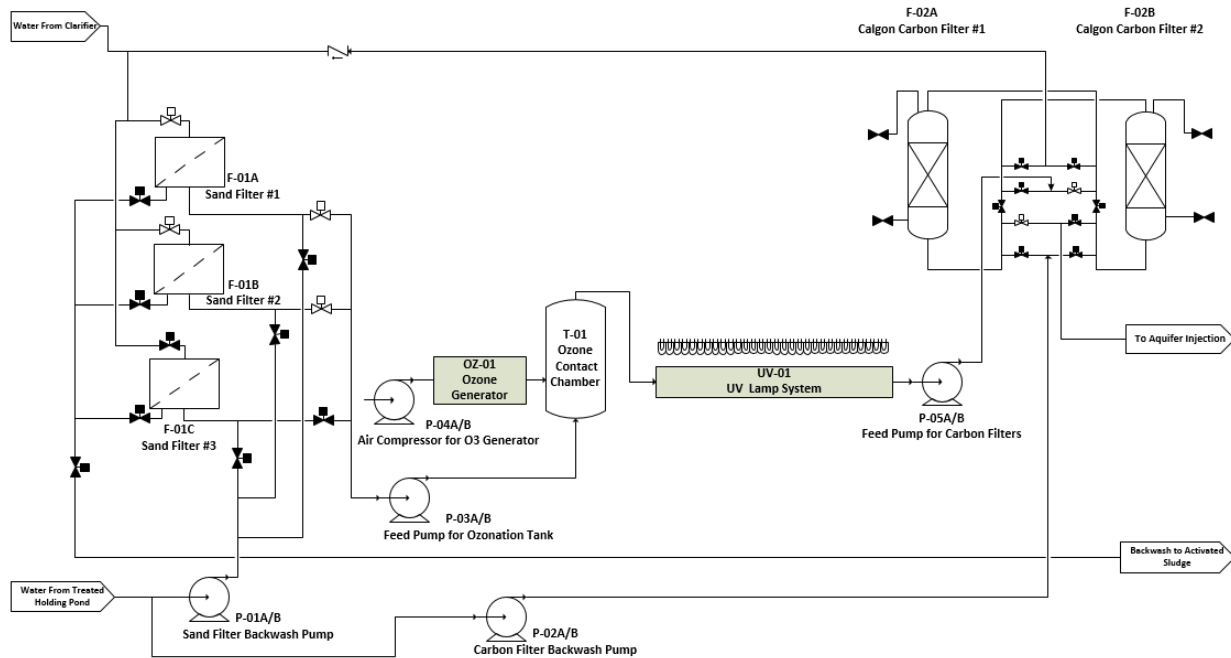

Figure 6: Process flow diagram for industrial scale system

9.6 Intended Water Reuse

The WWTP in Tucumcari, NM produces Class 1B wastewater. This effluent is sent to Breen’s pond where it flows to No Name Creek, then to Pajarito Creek in Quay County, New Mexico. Class 1B wastewater can legally be used on animal feed crops and fiber crops if adequate warning signs are posted on the borders of the property receiving the wastewater. This water cannot be used to irrigate food-bearing crops if there is a possibility of the treated wastewater touching the edible portion of the crop; therefore, spray irrigation of food bearing crops is prohibited. It is also important to note that spray irrigation is prohibited for Class 1A wastewater.³⁰ While the current wastewater effluent can be used for irrigation as is, unregulated contaminants and EDCs may be introduced to the environment. This is a problem as these contaminants may adversely affect the environment. The Woo-Pig-Sewage team has identified two potential uses for the reclaimed wastewater. These uses are direct aquifer injection and addition of the treated water to the existing canal system.

One community in New Mexico has already determined the efficacy and hazards of direct aquifer injection. The city of Rio Rancho, NM is in the process of installing equipment to directly inject treated effluent back into the main aquifer for the region. Their process utilizes a MBR system coupled with H₂O₂/O₃ treatment and GAC filtration. Ultimately, effluent from the proposed system for Tucumcari, NM, could be directly injected to their aquifer. Use of water in this way will require additional costs for injection as well as the addition of monitoring wells.

Another option for reuse is addition of the water to the canal system. Farmers in the area can use canal water to irrigate food crops, fodder, fiber crops and to water livestock. Water treated by the proposed system will exceed the standards for Class 1A wastewater. Class 1A wastewater can be used for all purposes except human consumption and spray irrigation of food crops. While these regulations exist for Class 1A wastewater, it may be possible to use the treated water for spray irrigation of food producing crops with the approval of the New Mexico Environment Department (NMED).

The NMED currently does not define a class of treated wastewater greater than Class 1A. However, the NMED reserves the right to determine water quality classification for all uses of wastewater not outlined by the NMED. The NMED will allow facilities to propose alternative wastewater quality levels, as long as the facility can demonstrate that the quality levels provide an equivalent measure of public health protection.³⁰ It is possible that the water usages listed above could be approved by the NMED as long as the health and environmental hazards are adequately evaluated and all health and safety precautions are taken.

10.0 ECONOMIC ANALYSIS

The economic analysis was performed for three different systems: Tucumcari's WWTP with a projected average flow of 300,000 gpd and two 144,000 gpd systems to meet the requirements of the WERC wastewater reuse prompt. One 144,000 gpd system was assumed to have existing UV treatment for comparison with the Tucumcari system and the other 144,000 gpd system was assumed to not have existing UV treatment for a cost analysis. The fixed capital investment (FCI) was calculated using the basis that 23% of the total FCI is the cost of purchased equipment. Each FCI cost category percentage in Table 4 was taken from the fifth edition of Plant Design and Economics for Chemical Engineers.³¹ The purchased equipment cost was the basis for calculating each FCI cost category. The purchase of new land, however, is not required.

While additional space will be required for the proposed process, there is assumed to be adequate space available. Due to this, the contribution to the FCI for the purchase of land is zero. The purchased equipment cost for the Tucumcari WWTP included pumps, compressors, an O₃ skid unit, GAC filtration system, and a sand filtration system. An additional cost for vents and fans for the existing UV building was added to address the release of off gases through the open-channel UV system. The purchased equipment costs for the 144,000 gpd systems included pumps, compressors, an O₃ skid unit, GAC filtration system, and a sand filtration system. The purchased equipment cost for the 144,000 gpd system, without an existing UV system, also included the price of a closed-vessel UV system. The closed-vessel UV system was chosen over the open-channel system to avoid the release of residual O₃ and off gases. The cost estimate for the 144,000 gpd system, with an existing UV system, was performed for comparison with the Tucumcari system. The equipment costs of the O₃ skid unit, UV closed-vessel system, and GAC filtration systems were provided by the equipment manufacturers. The FCI comparison can be seen in Table 4.

Table 4: Fixed Capital Investment Comparison

| | | Tucumcari (300,000 gpd) | 144,000 gpd | 144,000 gpd |
|---------------------------------|--------------------|------------------------------------|-----------------------|-----------------------|
| | Existing UV System | YES | YES | NO |
| FIXED CAPITAL INVESTMENT | % FCI | Cost | Cost | Cost |
| PURCHASED EQPT | 23.0% | \$458,935.00 | \$321,017.94 | \$431,517.94 |
| INSTALLATION | 8.3% | \$165,615.67 | \$115,845.60 | \$155,721.69 |
| INTRUMENT/CONTROLS | 9.2% | \$183,574.00 | \$128,407.18 | \$172,607.18 |
| PIPING | 7.3% | \$145,661.98 | \$101,888.30 | \$136,960.04 |
| ELECTRICAL | 4.6% | \$91,787.00 | \$64,203.59 | \$86,303.59 |
| BUILDINGS | 4.6% | \$91,787.00 | \$64,203.59 | \$86,303.59 |
| YARD IMPROVEMENT | 1.8% | \$35,916.65 | \$25,123.14 | \$33,770.97 |
| SERVICE FACILITIES | 13.8% | \$275,361.00 | \$192,610.76 | \$258,910.76 |
| LAND | 0.0% | - | - | - |
| ENGR & SUPERVISION | 7.3% | \$145,661.98 | \$101,888.30 | \$136,960.04 |
| CONSTRUCTION EXPENSE | 9.2% | \$183,574.00 | \$128,407.18 | \$172,607.18 |
| LEGAL | 1.8% | \$35,916.65 | \$25,123.14 | \$33,770.97 |
| CONTRACTOR FEE | 1.8% | \$35,916.65 | \$25,123.14 | \$33,770.97 |
| CONTINGENCY | 7.3% | \$145,661.98 | \$101,888.30 | \$136,960.04 |
| TOTAL: | 100% | \$1,995,369.57 | \$1,395,730.17 | \$1,876,164.96 |

The annual costs for the three systems were calculated with three lending examples over a 30-year payment period. The first cost comparison was calculated with the assumption that a Federal Grant would cover 100% of the FCI. The second comparison was calculated with the assumption that a Federal Grant would cover 50% of the FCI and the remaining 50% would be covered with a 0% interest federal subsidized loan. The final comparison was calculated with the assumption that 100% of the FCI is covered by a 6% interest commercial loan. The yearly operating costs for the three systems included utility requirements for all equipment, additional labor, additional sample testing, and carbon regeneration. The yearly operating costs for the 144,000 gpd plant without an existing UV system also included utilities for the UV system and bulb replacement. The cost comparison can be seen in Table 5 below.

Table 5: Annual Cost Comparison

| | Tucumcari (300,000 gpd) | 144,000 gpd | 144,000 gpd |
|--|------------------------------------|--------------------|--------------------|
| Existing UV System | YES | YES | NO |
| YEARLY OPERATING COSTS | | | |
| 100% Grant | \$107,868.34 | \$92,799.58 | \$166,079.58 |
| 50% Grant, 0% Federal Subsidized Loan (30 yr) | \$141,124.50 | \$116,061.75 | \$197,348.99 |
| 0% Grant, 6% Commercial Loan (30 yr) | \$252,829.76 | \$194,197.85 | \$302,380.92 |
| COST PER 1000 GAL | | | |
| 100% Grant | \$0.99 | \$1.77 | \$3.16 |
| 50% Grant, 0% Federal Subsidized Loan (30 yr) | \$1.29 | \$2.21 | \$3.75 |
| 0% Grant, 6% Commercial Loan (30 yr) | \$2.31 | \$3.69 | \$5.75 |

The cost per 1000 gal for wastewater treatment is significantly reduced with a higher flow rate, shown in Table 5, from the comparison of the Tucumcari WWTP with the 144,000 gpd (with existing UV system). It is therefore suggested that the proposed AOP-GAC system would be more cost effective in facilities with larger flow rates.

An option for funding in New Mexico is the Clean Water State Revolving Loan Fund (CWSRF) administered by the NMED. This goal of the CWSRF is “to provide local authorities with low-cost assistance to construct and rehabilitate wastewater facilities”. Under the “Eligible Expenditures” section of the CWSRF it is stated that “some communities may qualify for 0% interest” if the community meets the guidelines of the Federal Clean Water Act.³² For

smaller communities with lower median household incomes (MHI) this may be a feasible option for funding the proposed treatment system.

11.0 SAFETY AND ENVIRONMENTAL

General wastewater safety precautions should be taken as mandated by state and national laws and regulations.

Caffeine

Caffeine is a known environmental hazard for the golden orfe fish at 87 ppm for an exposure that exceeds 96 hours. The water flea has a 48 hour toxic dose of 182 ppm and green algae has a 72 hour toxic dose of 100 ppm.³³

Chlorpyrifos

CLP is lethal to fathead minnows at 0.15 ppm for 48 hours and acts as a growth inhibitor at 0.003 ppm for seven days. Water fleas have a 48 hour lethal dose of 5.0×10^{-4} ppm. It was also shown to bio-accumulate in fathead minnows by a factor of 23,000 over 100 days at a dose of 4.8×10^{-4} ppm.³

Ozone

O₃ is a colorless gas that is most readily observed at concentrations above 0.01 ppm by its strong odor. There are some health risks associated with O₃ inhalation. Based on OSHA recommendations, short term exposure above 0.1 ppm could lead to irritated mucous membranes and coughing. There is also a risk of disorientation, fatigue, increased sensitivity to allergens, and aggravation of respiratory conditions. Extremely high doses could cause pulmonary edema; however there are no known chronic effects. O₃ is highly unstable and reactive. O₃ is reactive with oxidizable substances, aromatic compounds, rubber, steel, nylons, and some plastics. While not hazardous, contact with skin or eyes should be avoided. As a heavy oxidizer, O₃ is not directly flammable but fuels combustion and explosion at concentrations above 50ppm.³⁴

12.0 CONCLUSIONS AND RECOMMENDATIONS

- Both CLP & caffeine were reduced to concentrations below detectable limits by the proposed treatment system
- O₃ was effective in the reduction of caffeine concentrations but appeared to have minimal effect on CLP concentration

- UV did not appear to be effective for either contaminant as a stand alone treatment method or in conjunction with O₃
- GAC reduced contaminant concentrations below detectable limits in all cases
- Ultimately, the proposed system will be the most cost effective if the total value of the FCI can be awarded to the community in the form of a grant. If a 100% grant is awarded, the cost per 1000 gallons of water in Tucumcari will only increase by \$0.99.
- NMED approval of wastewater treated by the proposed system could greatly increase the potential for reuse.
- While O₃ and UV did not appear to reduce concentrations in all cases it should not be dismissed. Further research into optimal O₃ dosage as well as optimal UV wavelength will need to be conducted for wastewater applications.
- Further research will need to be conducted to address the complex and varying nature of wastewater and contaminants before the proposed reuse of the wastewater can be implemented.

13.0 ACKNOWLEDGEMENTS

Thank you Dr. Shannon Servoss, Dr. Robert Cross, Marian Wrage and the Rio Rancho, NM Team; Calvin Henson and Thomas from Tucumcari, NM; Barbara Cooney and Damon McElroy with the EPA. The U of A Department of Chemical Engineering, as well as Karl Pennock and Adam Brennan for auditing our paper.

14.0 REFERENCES

1. Affairs, U. N. D. o. E. a. S., Water Scarcity. 2007.
2. Diano, N.; Gustavo Mita, D. Removal of Endocrine Disruptors in Waste Waters by Means of Bioreactors. <http://cdn.intechopen.com/pdfs-wm/14548.pdf>.
3. Sigma-Aldrich, Chlorpyrifos Safety Data Sheet.
4. Schulman, I.; Throw, D., Photocatalytic Oxidation for the Removal of Chlorpyrifos from Aqueous Solution. 2013.
5. Agency, E. P. Fourth Unregulated Contaminant Monitoring Rule. <http://www.epa.gov/dwucmr/fourth-unregulated-contaminant-monitoring-rule>.
6. University, N. M. S., IEE/WERC International Environmental Design Competition. 2016.
7. Rathi, A. K. A.; Puranik, S. A., Chemical Industry Wastewater Treatment Using Adsorption. *Journal of Scientific & Industrial Research* **2001**, *61*, 53-60.
8. Worch, E., *Adsorption Technology in Water Treatment Fundamentals, Processes, and Modeling*. Walter de Gruyter GmbH & Co. Kg Berlin/Boston: Berlin/ Boston, 2012.

9. Grassi, M.; Kaykioglu, G.; Belgiorno, V.; Loran, G. Removal of Emerging Contaminants from Water and Wastewater by Adsorption Process.
http://www.springer.com/cda/content/document/cda_downloaddocument/9789400739154-c2.pdf?SGWID=0-0-45-1326966-p174282986.
10. Snyder, S. A.; Adam, S. R., Adam M.; Cannon, F. S.; DeCarolis, J.; Oppenheimer, J.; Wert, E. C.; Yoon, Y., Role of Membranes and Activated Carbon in the Removal of Endocrine Disruptors and Pharmaceuticals. 2006.
11. Cecen, F.; Aktas, Ö., Activated Carbon for Water and Wastewater Treatment: Integration of Adsorption and Biological Treatment. John Wiley & Sons: 2011.
12. Technologies, U. Hydrogen Peroxide is a Powerful Oxidizer.
<http://www.h2o2.com/products-and-services/us-peroxide-technologies.aspx?pid=112>.
13. Associates, W. E. Hydrogen Peroxide Addition. <http://www.odor.net/hydrogen-peroxide-addition/>.
14. Lenntech Disinfectants Hydrogen peroxide.
<http://www.lenntech.com/processes/disinfection/chemical/disinfectants-hydrogen-peroxide.htm>.
15. Technologies, U., OD and COD Removal Hydrogen Peroxide (H2O2). 2016.
16. Snyder, S. A.; Wert, E. C.; Rexing, D. J.; Zegers, R. E.; Drury, D. D., Ozone Oxidation of Endocrine Disruptors and Pharmaceuticals in Surface Water and Wastewater. *International Ozone Association* **2006**, 28, 445-460.
17. Appendix D.5. Documentation of BMP Ability to Meet the 80% TSS Removal Requirement.
http://www.mde.state.md.us/assets/document/sedimentstormwater/Appnd_D5.pdf.
18. University, P., Sand Filters.
19. McGowan, W. Particle Size Chart in Water Processing textbook.
<https://www.h2odistributors.com/chart-particle-sizes.asp>.
20. Lee, C. O.; Howe, K. J.; Thomson, B. M. State of Knowledge of Pharmaceutical, Personal Care Product, and Endocrine Disrupting Compound Removal during Municipal Wastewater Treatment. http://www.unm.edu/~howe/UNM_Howe_PPCP_Final_Report.pdf.
21. Litter, M. I.; Candal, R. J.; Meichtry, J. M., Advanced Oxidation Technologies: Sustainable Solutions for Environmental Treatments. CRC Press: 2014.
22. TRE Case Study: Central Contra Cost Sanitary District, Martinez, California, and Other San Francisco Bay Area POTWs.
23. Organization, W. H., Rapid Sand Filtration Fact Sheet 2.14.
24. Agency, E. P. Wastewater Technology Fact Sheet Ozone Disinfection.
<https://www3.epa.gov/npdes/pubs/ozon.pdf>.
25. Couch, B., The Ozone/UV Combination.
26. Cross, G.; Cushing, R.; Rennecker, J.; Cleveland, C.; Wright, H., Synergies of UV Disinfection and Ozone in Water Treatment.
27. Background Information for Chlorpyrifos.
28. Aeppli, J.; Dyer-Smith, P., OZONATION AND GRANULAR ACTIVATED CARBON FILTRATION THE SOLUTION TO MANY PROBLEMS. Ozonia Ltd Duebendorf, Switzerland, 1996.
29. Agency, E. P., Granular Activated Carbon.
30. Mexico, N.; Guidance, E. D. Q. B., ABOVE GROUND USE OF RECLAIMED DOMESTIC WASTEWATER. 2007.

31. Peters, M.; Timmerhaus, K.; West, R., *Plant Design and Economics for Chemical Engineers*. 5th ed.; McGraw Hill Education: 2003.
32. Legislature, N. M., New Mexico Water and Wastewater Funding Sources.
33. Sigma-Aldrich, Caffeine Safety Data Sheet. 2016.
34. CB&I, Ozone Safety Data Sheet.