

University of Arkansas, Fayetteville

ScholarWorks@UARK

---

Chemical Engineering Undergraduate Honors  
Theses

Chemical Engineering

---

12-2018

## Removal of Carbamazepine From Drinking Water

Adam Johnson

*University of Arkansas, Fayetteville*

Thomas Krumpolc

*University of Arkansas, Fayetteville*

Jordan Gadberry

*University of Arkansas, Fayetteville*

Juan Rodriguez

*University of Arkansas*

Paolo Marrero-Rivera

*University of Arkansas, Fayetteville*

*See next page for additional authors*

Follow this and additional works at: <https://scholarworks.uark.edu/cheguht>

 Part of the [Transport Phenomena Commons](#)

---

### Citation

Johnson, A., Krumpolc, T., Gadberry, J., Rodriguez, J., Marrero-Rivera, P., & Wiese, Z. (2018). Removal of Carbamazepine From Drinking Water. *Chemical Engineering Undergraduate Honors Theses* Retrieved from <https://scholarworks.uark.edu/cheguht/114>

This Thesis is brought to you for free and open access by the Chemical Engineering at ScholarWorks@UARK. It has been accepted for inclusion in Chemical Engineering Undergraduate Honors Theses by an authorized administrator of ScholarWorks@UARK. For more information, please contact [scholar@uark.edu](mailto:scholar@uark.edu), [uarepos@uark.edu](mailto:uarepos@uark.edu).

---

**Author**

Adam Johnson, Thomas Krumpolc, Jordan Gadberry, Juan Rodriguez, Paolo Marrero-Rivera, and Zachary Wiese

Adam Johnson

## Removal of Carbamazepine from Drinking Water

I was chosen to be the team coordinator for task 5, Removal of Carbamazepine from drinking water, for the NMSU WERC design competition. In the beginning of the competition, the main purpose of this roll was to allocated members to specific tasks. Throughout the competition, I was responsible for ensuring that fellow team members completed assignments in a timely and appropriate manner. Furthermore, I co-led all experiments regarding granular activated carbon and the data analysis. This included batch experiments that determined the feasibility of granular activated carbons ability to adsorb carbamazepine. These batch experiments included two different types of granular activated carbon, which caused us to have to run each experiment twice. With this data I derived a pseudo-first order kinetics models, which allowed us to understand the effectiveness of each carbon and which one was most effective. The data I helped collect from the batch experiments was also modeled as a Freudliuch isotherm to determine how long the carbon would last. Once carbon was deemed as a potential solution, continuous process experiments were constructed. I helped design the system which included piping and adsorber size, all fittings, pump, motor, pressure safety valve, etc. Once the system was designed, I order the parts from Grainger and also made copious amounts of trips to Lowes to properly assemble the bench scale. Once the continuous process was constructed, a table of volume of granular activated carbon, vs effluent concentration of the systems was created for both carbons. This was data was then used to create a full scale design. Since I co-led all carbon experiments, I wrote the batch experiments section of the report. Lastly, I was a presenter in the presentation to the WERC judges at the competition.

## Appendix

# Removal of Carbamazepine from Drinking Water

WERC 2018

Task # 5

Carbamaza-Clean



Ralph E. Martin Department of Chemical Engineering  
University of Arkansas

# **Removal of Carbamazepine from Drinking Water**

**WERC 2018**

**Task #5**

March 15, 2018

**Carbamaza-Clean**

Alex Gadberry

Adam Johnson

Tom Krumpolc

Paola Marrero-Rivera

Juan Rodriguez

Zach Wiese

Faculty Advisors: Dr. Michael Ackerson

Dr. W. Roy Penney

Faculty Mentor: Dr. Tammy Lutz-Rechtin

**Ralph E. Martin Department of Chemical Engineering**

**University of Arkansas**

**Fayetteville, AR**

**Table of Contents**

**1.0 EXECUTIVE SUMMARY ..... 3**

**2.0 PURPOSE ..... 4**

**3.0 CONVENTIONAL TREATMENT METHODS ..... 4**

**4.0 CARBAMAZEPINE TREATMENT METHODS ..... 5**

**4.1 Activated Carbon Adsorption ..... 5**

**4.2 Ozone Oxidation ..... 6**

**4.3 Reverse Osmosis..... 7**

**5.0 TASK PREMISE ..... 7**

**6.0 ANALYTICAL TESTING ..... 7**

**6.1 Chemicals and Instrumentation ..... 8**

**6.2 Analytical Method ..... 8**

**6.3 Calibration Curves ..... 8**

**7.0 EXPERIMENTAL RESULTS AND DISCUSSION ..... 9**

**7.1 Ozone Oxidation ..... 9**

**7.2 Carbon Loading ..... 13**

**7.3 Packed Bed ..... 17**

**8.0 BENCH SCALE PROCEDURE ..... 19**

**9.0 INDUSTRIAL SCALE DESIGN ..... 20**

**9.1 Oxone Oxidation Scale Up ..... 20**

**9.2 Activated Carbon Adsorption Scale Up ..... 20**

**10.0 ECONOMIC ANALYSIS ..... 21**

**11.0 HEALTH AND ENVIRONMENTAL CONCERNS ..... 22**

**12.0 REGULATIONS AND FUTURE IMPACTS ..... 23**

**13.0 CONCLUSIONS AND RECOMMENDATIONS ..... 24**

**14.0 ACKNOWLEDGEMENTS ..... 24**

**15.0 REFERENCES ..... 25**

## 1.0 EXECUTIVE SUMMARY

Due to the increasing prevalence of prescription medication over the past few decades, pharmaceuticals have accumulated in various water sources. This has become a public health concern because many pharmaceuticals have limited research on the effects of chronic low-level exposure. According to the World's Health Organization (WHO), traces of pharmaceutical products have been reported in different water sources such as surface waters, wastewater, groundwater, and drinking water.<sup>[1]</sup> One pharmaceutical of interest that has been detected in water sources is carbamazepine. Carbamazepine (CBZ) is a common pharmaceutical prescribed for the treatment of seizure disorders, neuropathic pain, and various psychological disorders. Its mechanism of action is "sodium channel blocking," which is the impairment of conduction of sodium ions in sodium channels. This, in effect, reduces nervous-system conductivity in key areas related to the treated disorders mentioned above.<sup>[2]</sup>

Carbamazepine is also not easily biodegradable and current conventional treatment methods in some drinking water and wastewater facilities do not adequately remove carbamazepine and other pharmaceuticals from treated water. While carbamazepine is not federally regulated by the Environmental Protection Agency (EPA) under the Safe Water Drinking Act (SWDA) at this time, it does have the potential for producing adverse health effects in humans. Therefore, being proactive in finding ways to remove carbamazepine and compounds like it should be encouraged. The Carbamaza-Clean team designed a bench scale unit as well as an in-home treatment system using granular activated carbon (GAC) to effectively remove carbamazepine from water. GAC was chosen for this design because it is inexpensive and does not create by-products that are harmful to human health.

Several experiments were conducted to determine the efficiency of the removal of carbamazepine using two different GACs: coconut shell GAC (CSGAC) and bituminous coal GAC (BGAC). A packed bed column was constructed to determine if both carbons could reduce the concentration of carbamazepine from 1 ppm to 1 ppb or lower. The CSGAC packed bed was able to lower the concentration below 1 ppb at a packed bed length of 4.4 ft, while the BGAC only required half that (2.2 ft). Both carbons can remove carbamazepine to the desired concentration; however, the costs vary. An economic analysis was performed to determine the costs of the carbons. The CSGAC system would cost \$990 for the first year and \$589.68 for each



following year. The BGAC system would cost \$639 for the first two years, and then \$200 every two years following the initial capital investment.

## **2.0 PURPOSE**

An increase in demand for new freshwater sources has catalyzed the design for new water treatment technologies. Many communities typically reuse fresh water sources; however, there are many contaminants such as debris, microorganisms (bacteria and viruses), and micropollutants (pharmaceuticals, chemicals, pesticides, and hormones) that must be removed and treated before human consumption. Because of a lack of data, little is known about the potential health risks and environmental effects from chronic exposure to low concentrations of carbamazepine and its metabolites. Thus, more research must be conducted to understand the long-term implications on both human health and the environment. In addition, it is predicted that future regulations will encourage water treatment facilities to incorporate new treatment methods to remove carbamazepine and other pharmaceuticals.

## **3.0 CONVENTIONAL WATER TREATMENT METHODS**

Current conventional treatment methods in wastewater and drinking facilities do not adequately remove carbamazepine and other pharmaceuticals from water. These methods typically expose micropollutants to a series of treatment processes, including sedimentation tanks to remove suspended solids, activated sludge, dispersion, partition, biodegradation, and abiotic transformation.<sup>[3]</sup> While many micropollutants are effectively removed mainly by adsorption on primary sludge, pharmaceuticals and hormone adsorption to sludge particles has proven to be insufficient.<sup>[4]</sup> At best, these conventional process steps are only able to remove trace amounts of pharmaceuticals and some of the human metabolites/transformation products in the influent may revert back to the parent compound during the biological treatment steps.<sup>[4]</sup>

Coagulation-flocculation is used for removing particulate matter, colloids, as well as some dissolved substances. For example, Matamoros and Salvadó evaluated micropollutant removal in a system that consisted of coagulation, flocculation, filtration (pulsed-bed sand filters), UV light lamps, and chlorination in treating secondary effluent.<sup>[5]</sup> The percent removal of carbamazepine was the lowest of the compounds evaluated, coming in at 2% removal.<sup>[5]</sup> There were varying degrees for the removal of carbamazepine in the studies that were related to plant-specific factors such as the composition of wastewater (i.e. the mixture of micropollutants) and the treatment operating conditions and processes (i.e. mixing conditions, temperature, pH, etc.).

But, in each case, carbamazepine was consistently one of the most persistent pharmaceuticals studied.

Diclofenac and naproxen, two anti-inflammatory drugs that are also known to be highly persistent through traditional treatment processes, both showed sufficient elimination (~60%) through nanofiltration membrane treatment.<sup>[6]</sup> However, carbamazepine was retained. Membrane bioreactor (MBR) processes combine activated sludge biological treatment and membrane filtration (MF and UF). Through six studies with varying membrane and experimental conditions, carbamazepine was removed 24% at most.<sup>[7]</sup> This study, conducted by Trinh et al. (2012), had a solid retention time of 10-15 days, which is a significantly longer time than other removal methods that have been researched.

#### **4.0 CARBAMAZEPINE TREATMENT METHODS**

##### **4.1 Activated Carbon Adsorption**

One method that has shown improvement in carbamazepine removal over conventional water treatment methods is adsorption. Adsorption is the process of adhering molecules or atoms of a chemical species onto the surface of a sorbent either through reversible weak interactions (Van der Waals) or irreversible chemical bonds.<sup>[8]</sup> The adsorbent has a limited capacity for adsorption based on the surface area of the particle. Activated carbon is a preferred adsorbent due to its high surface area and low cost. Several studies have been conducted to compare the adsorption capacity of carbamazepine on several adsorbents. Some of the adsorbents tested included GAC, powder activated carbon (PAC), and hexagonal mesoporous silicate (HMS).

GAC is one of the materials that is used in typical cartridge filters. These filters are readily available, inexpensive, and come in various sizes. Not every GAC is the same and can be manufactured from different materials, such as coal, coconut shells, and wood. Some households currently use cartridge style filters to treat water in their homes, and appropriate housing and filters are readily available at hardware stores, e.g. Lowes or Home Depot.

PAC is similar to GAC in that it is activated carbon, but it has a smaller particle size, less than 0.1mm in diameter, and must be utilized using a different technique. In Figure 4.1, a typical process flow diagram of PAC is shown. It is fed as either a slurry or powder and mixed with the water that needs to be treated. The longer that PAC is in contact with water, the greater the adsorption. Some PAC can be removed by allowing the mixture to settle; however, this takes time and would not work in an “on demand” style water treatment for a home. This sediment

would also have to be removed and discarded, which is a further inconvenience to a homeowner. The water then must be filtered to remove the remaining PAC. Although PAC has a greater adsorption capacity than GAC, it introduces more steps, which makes this method less economically favorable.<sup>[8]</sup>

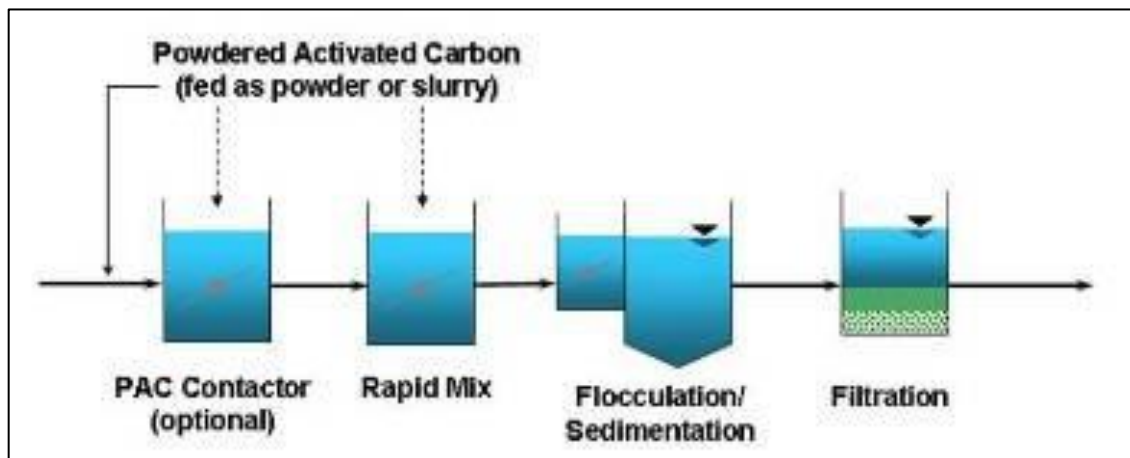

Figure 4.1: PAC Process

Some research has been done on the adsorption of carbamazepine onto hexagonal mesoporous silicate HMS, SBA-15, MCM-41, and two functionalized derivatives of HMS: one with an amine group and one with a mercapto group. These are highly specialized materials that are expensive. According to Sigma-Aldrich, SBA-15 is approximately \$200 for 5g. These types of adsorbents have capacities for absorbing carbamazepine between GAC and PAC. The m-HMS with the mercapto group had the next highest adsorption capacity.<sup>[9]</sup> m-HMS is not the best option for a home scale unit due to its high cost and because its absorptivity must be enhanced by modifying the original structure.

#### 4.2 Ozone Oxidation

Ozone oxidation is widely used in drinking water applications and in some wastewater treatment plants. Ozone can oxidize and breakdown larger molecules into smaller molecules with a higher affinity to biodegrade. This method is typically used to improve taste, odor, color, and disinfection of untreated water. Furthermore, it has been shown that ozone reacts quickly with the double bond in carbamazepine to yield several ozonation products. McDowell et al. conducted a study where the by-products for the ozone oxidation of carbamazepine were identified. The major by-products, BQM, BQD, and BaQD are depicted in the reaction mechanism of Figure 4.2.<sup>[10]</sup>

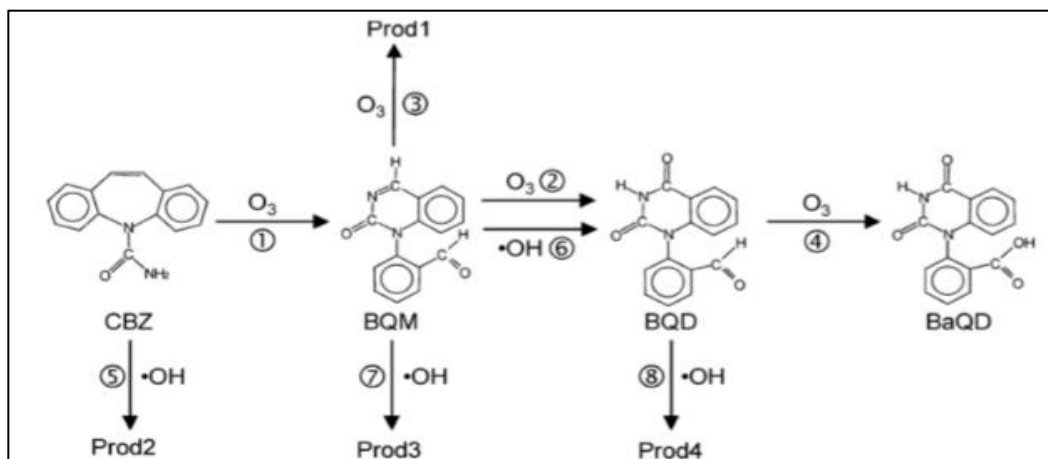

Figure 4.2: Proposed Reaction Pathways for the Ozone Oxidation of Carbamazepine

### 4.3 Reverse Osmosis

Reverse osmosis (RO) is an effective method of removing carbamazepine from drinking water. A study conducted in South Korea demonstrated that RO brought concentrations of carbamazepine below detectable limits.<sup>[11]</sup> However, RO is a more expensive process due to constant fouling, easily damaged membranes, and the production of a concentrated waste stream. Disposing of the retentate stream as well as maintaining the membrane system will be a complicated, expensive, and cumbersome effort to maintain a home scale unit. This is not favorable from an economic or ease-of-use standpoint.

### 5.0 TASK PREMISE

The purpose of this task is to develop an economical, in-home solution to remove carbamazepine from 100 gallons per day of water. The considerations for this task are as follows:

- Develop and test a prototype capable of treating 8 gallons of water in a two-hour period.
- The prototype (and final full-scale design) must be able to remove carbamazepine from an entering concentration of 1 ppm to an exit concentration 1 ppb.
- The full-scale design must have an energy requirement that does not exceed 1 kWh/day.
- The resulting treated water must be safe for human consumption.

### 6.0 ANALYTICAL TESTING

Carbamazepine is one of few pharmaceutical tested researched because it is resistant to water treatment methods and has limited biodegradability.<sup>[12]</sup> The EPA method for testing pharmaceuticals and personal care products (PPCPs) in drinking water utilizes solid phase extraction followed by liquid chromatography combined with tandem mass spectroscopy (SPE LC/MS-MS).<sup>[12], [13], [14], [15]</sup>

The samples for this testing procedure are solutions of milli-Q purified water (17.5 MOhms) doped with carbamazepine and sucrose. Testing was conducted using a high-performance liquid chromatograph with a photodiode array detector (HPLC-PDA) and liquid chromatography electrospray ionization tandem mass spectrometry (LC/ESI-MS/MS). The limit of detection (LOD) was calculated for both methods; the HPLC-PDA had a LOD of 172 ppb, while the LC/ESI-MS/MS had a LOD of 50 ppt. HPLC-PDA was the primary sample testing method due to ease of access and cost; however, if the limit of detection was exceeded, samples were analyzed using LC/ESI-MS/MS.

### **6.1 Chemicals and Equipment**

The chemicals used were carbamazepine, sucrose, and methanol purchased from Sigma-Aldrich. The following instrumentation was used for testing in the Chemical Engineering laboratory: a C18 HPLC column, a HPLC PDA, nanopure water filters, analytical balances, hot plates and stirrers, pipettes, beakers, conical vials, methanol, acetonitrile, and trifluoroacetic acid (TFA). A LC/ESI-MS/MS was also utilized at the statewide mass spectroscopy facility on campus for samples which exceeded the limits of detection of the HPLC-PDA.

### **6.2 Analytical Method**

The method used for testing carbamazepine is an industrial standard HPLC protocol. Carbamazepine was measured using a 5 - 95% acetonitrile and water gradient with 0.1% TFA. The PDA, which calculates the absorbance of a compound based on the principles of Beer's Law, was set to read at 285.5 nm because this is the maximum wavelength absorbance for carbamazepine <sup>[16]</sup>. Carbamazepine eluted off the HPLC column at approximately 19.5 minutes.

### **6.3 Calibration Curves**

A calibration curve was developed to determine the concentration of experimental samples. Carbamazepine was initially dissolved in a 30% methanol solution due to its low solubility in pure water. This solution was then diluted to varying concentrations in water.

The standard concentrations were plotted against the area of the carbamazepine absorption peak from the HPLC results, and the data was fitted with a linear regression. The coefficient of determination ( $R^2$ ) was approximately one, indicating a near perfect linear relationship of the line to the diluted concentrations. The calibration curves in Figure 6.3A and Figure 6.3B were used to determine the concentrations of unknown samples.

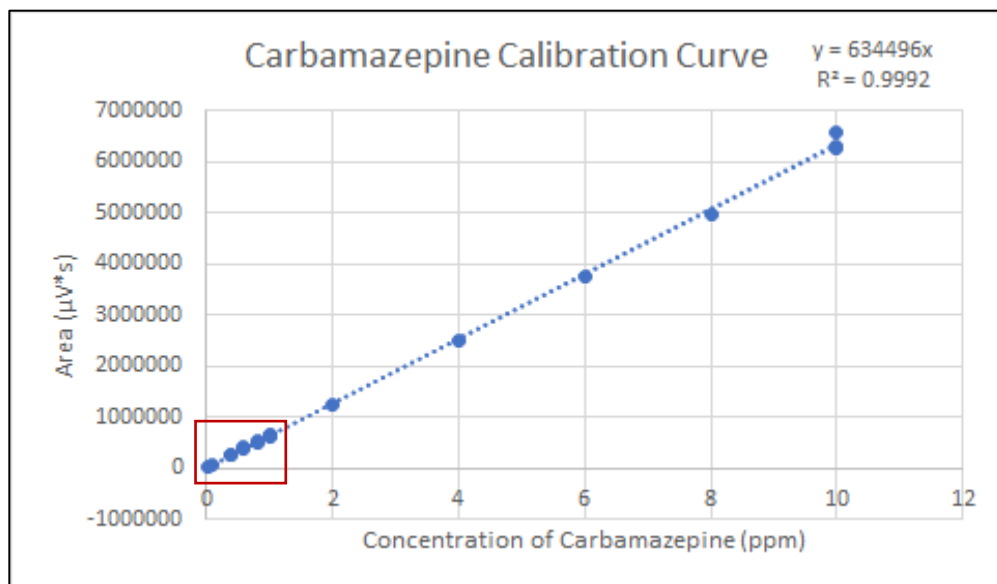

Figure 6.3A: Carbamazepine Calibration Curve (1 - 10 ppm)

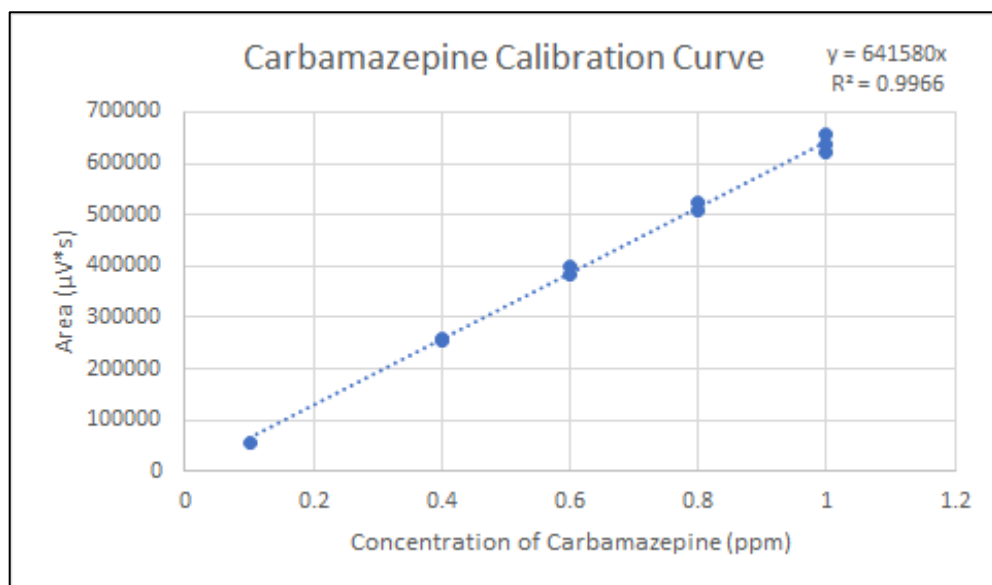

Figure 6.3B: Carbamazepine Calibration Curve (0.1 - 1 ppm)

## 7.0 EXPERIMENTAL RESULTS AND DISCUSSION

### 7.1 Ozone Oxidation Experiment

#### 7.1.1 Experimental Setup

Many studies have shown ozone to effectively degrade carbamazepine. Two experiments were performed at different carbamazepine concentrations to determine the rate at which it is degraded by ozone. The experiments were constructed by using the following equipment: a Microzone 300 generator, lab air supply, a 500 mL beaker, two baffles created from bent copper

tubes, a stirrer, a needle valve, and plastic tubing to connect the air supply to the needle valve, the needle valve to the ozone generator, and the ozone generator to the beaker. The experimental setup is shown in Figure 7.1.1.

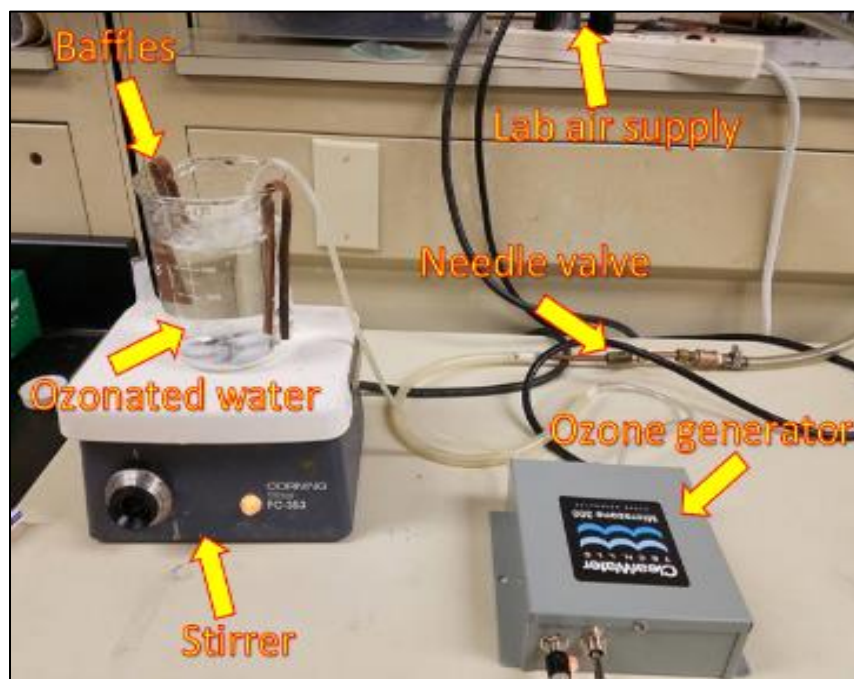

Figure 7.1.1: Ozone Experimental Setup

The ozone generator used for these experiments produces a maximum ozone output of 0.3 g/hr at 6 SCFH (2.83 L/min) on ambient air. Using Henry's Law as an estimation for this open system, the concentration of ozone soluble in 500 mL of water was determined to be about 8.85  $\mu\text{mol O}_3/\text{L}$  water. The ozone specifications from both experiments are shown in Table 7.1.1.

Table 7.1.1: Ozone Specifications

Production rate of ozone ( $\text{gO}_3/\text{hr}$ )	0.3
Air flow rate (L/min)	2.83
Weight percent of ozone based on air at 23°C	0.148%
Mole percent of ozone based on air at 23°C	0.0893%
Amount of ozone in air ( $\text{mg O}_3/\text{L}$ air)	1.77
Solubility ratio of $\text{O}_3$ gas volume to $\text{O}_3$ liquid volume soluble in water at 20°C and 1 atm	0.24
Amount of ozone dissolved in water ( $\text{mg O}_3/\text{L}$ water)	0.425

Concentration of ozone dissolved in 500 mL water ( $\mu\text{mol O}_3/\text{L water}$ )	8.85
Ozone generator power consumption (kW)	.3

### 7.1.2 Ozone Oxidation Procedure and Results

The two experiments were performed at ambient temperature (23-25°C) and at atmospheric pressure (1 atm). For the first experiment, a 500 mL water solution of 12.107 ppm carbamazepine and 250 ppm sucrose was ozonated. Samples were taken at time zero and at 1/2, 1, 3, 5, 10, 15, 25, 45, 60, and 120 minutes after the experiment had started. An HPLC was used to determine the concentrations of each sample. Figure 7.1.2 below shows the change in concentration of carbamazepine over time for the first experiment.

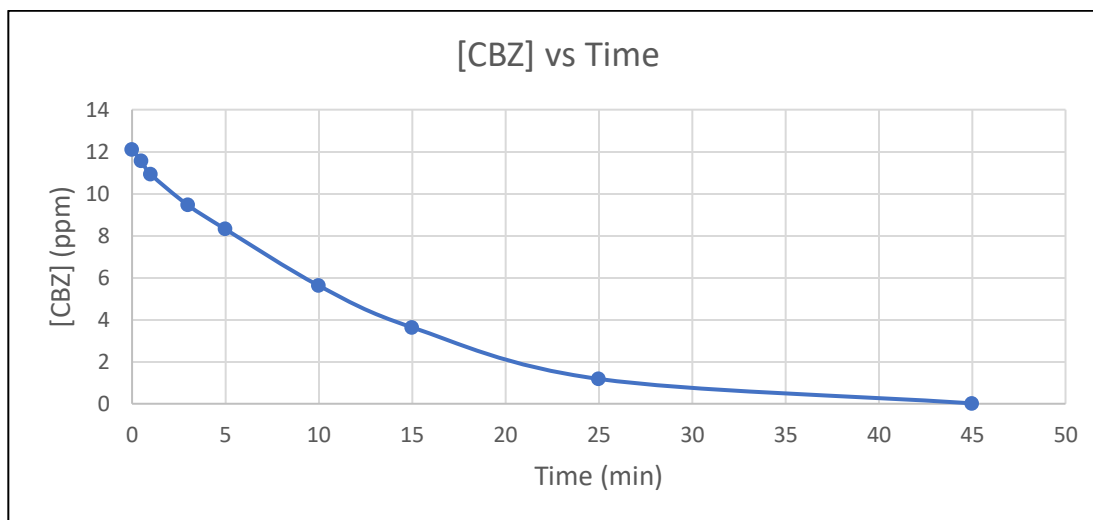

Figure 7.1.2 Concentration of Carbamazepine vs Time for First Experiment

From this data, it took 45 minutes for the ozone to decrease the concentration of carbamazepine to about 0.0190 ppm (19.0 ppb), which is about 99.8% conversion. The problem that emerged with the first experiment was that the concentration of ozone soluble in water (8.85  $\mu\text{mol O}_3/\text{L water}$ ) was too low to decrease the concentration of carbamazepine (51.243  $\mu\text{mol carbamazepine}/\text{L water}$ ) at a reasonable rate. The molar ratio of carbamazepine to ozone in water was nearly 6:1. As a result, this prolonged the degradation of carbamazepine. Since the solubility of ozone in water increases with increasing pressure, a potential solution was to perform the experiment again at a higher pressure. However, the solution chosen for the second experiment was to maintain the same process but decrease the concentration of carbamazepine to 1ppm (4.23  $\mu\text{mol carbamazepine}/\text{L water}$ ). This changed the molar ratio of carbamazepine to ozone to approximately 1:2 and increased the degradation rate.



For the second experiment, the 500 mL water solution had 0.999 ppm carbamazepine and 25 ppm sucrose. Samples were taken at time zero and at 1/2, 1, 2, 3, 5, 7, 10, 15, 20, 40, and 60 minutes after the experiment had started. The change in carbamazepine concentration over time for the second experiment is shown in Figure 7.1.3.

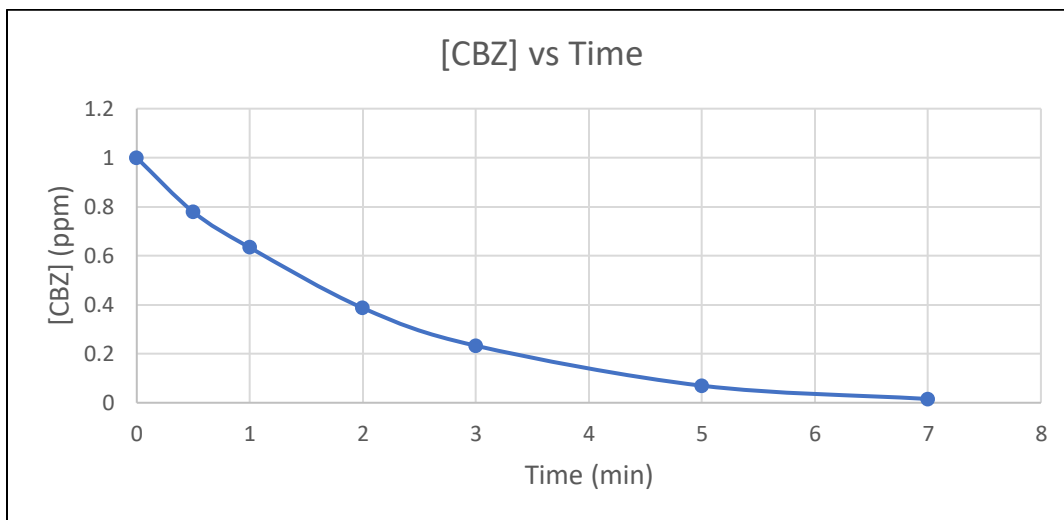

Figure 7.1.3: Concentration of Carbamazepine vs Time for Second Experiment

In contrast to the first experiment, it took only 7 minutes for the ozone in the second experiment to decrease the concentration of carbamazepine to about 0.0154 ppm (15.4 ppb), which is about 98.5% conversion. Further analysis of the data from both experiments concluded that the reaction was first order with respect to carbamazepine; however, the reaction order with respect to ozone could not be experimentally determined because it could not be measured. McDowell et al. concluded in a study that the reaction was first order in respect to both carbamazepine and ozone.<sup>[10]</sup>

To formulate a rate expression for each experiment with respect to the concentrations of carbamazepine and ozone, it was assumed that the ozone concentration was constant because ozone was continuously generated and saturating the solution. Thus, the reaction was zero order in respect to ozone. From this assumption, the overall reaction rate expression and rate constant for the first experiment was as follows:

$$r = 0.1354[CBZ] \frac{\text{mol}}{\text{L} * \text{min}} \quad k = 0.1354 \frac{1}{\text{min}} \quad (7.1.1)$$

The overall reaction rate expression and rate constant for the second experiment was as follows:

$$r = 0.5867[CBZ] \frac{\text{mol}}{\text{L} * \text{min}} \quad k = 0.5867 \frac{1}{\text{min}} \quad (7.1.2)$$

Below, Figure 7.1.4 depicts the first order test for the second experiment. The same process was used for the first experiment.

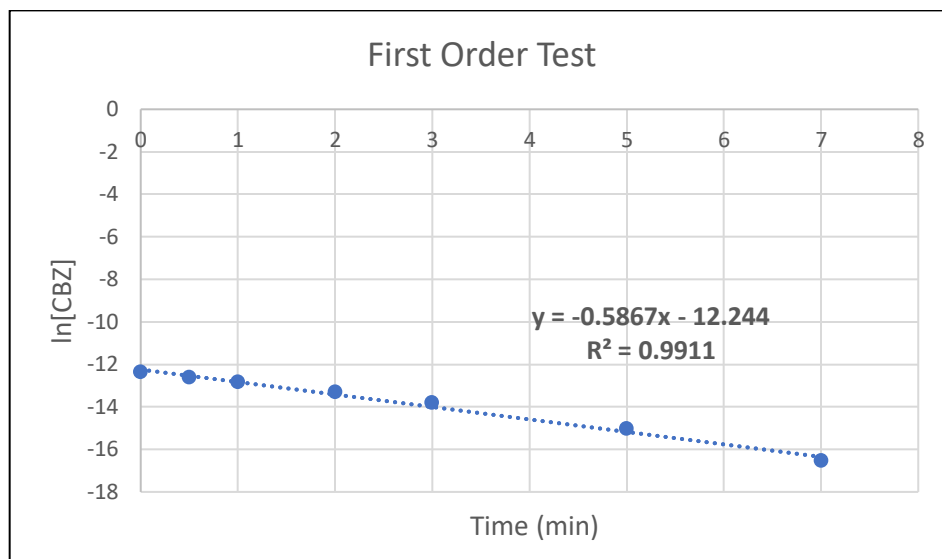

Figure 7.1.4: First Order Test for Second Experiment

Although ozone quickly degrades carbamazepine, when a plug flow reactor was modeled, the necessary volume for the desired conversion was too large for an at-home application.

## 7.2 Carbon Loading Experiment

### 7.2.1 Experimental Setup

Another possible solution for removing carbamazepine from drinking water is by using activated carbon filters. Activated carbon can be produced from a variety of materials, including wood, charcoal, and coconut shells. With a global abundance of the raw materials needed to make activated carbon, it is readily available and fairly inexpensive.<sup>[17]</sup> To determine if activated carbon is effective in adsorbing carbamazepine, two different carbons were studied. The first carbon to be evaluated was coconut shell granular activated carbon (CSGAC) from replacement water filter. This carbon was chosen because it is cheap, easy to purchase, and was listed as being effective for pharmaceutical removal. The alternative carbon tested was bituminous coal granular activated carbon (BGAC), which was also listed as being effective at removal of pharmaceuticals from aqueous solutions. For both carbons, rates of adsorption, max adsorption of carbamazepine, and effects of sucrose on adsorption rates were experimentally determined. Scanning electron microscope images of both carbons are included below. The difference in porosity and surface area between the two carbons can be clearly seen in these images. Due to these physical attributes, BGAC was expected to outperform CSGAC.

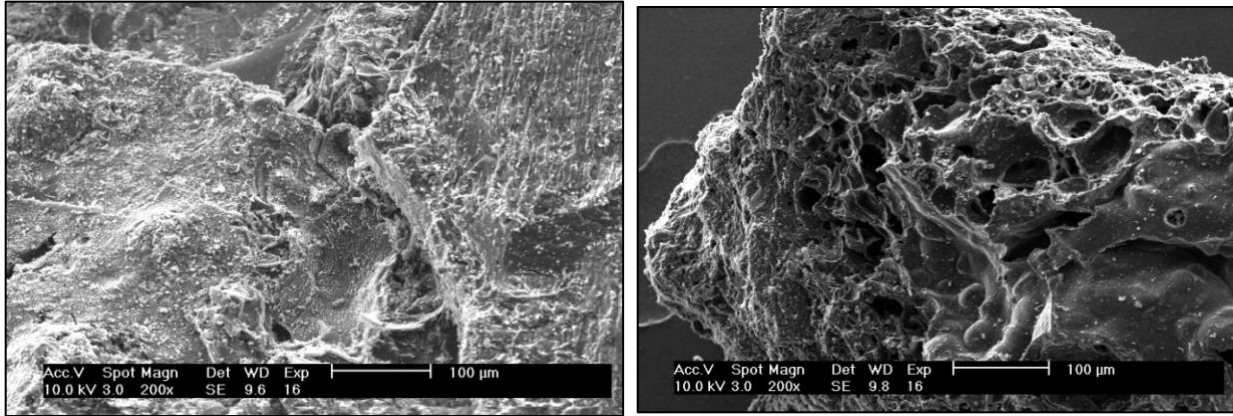

Figure 7.2.1 Scanning Electron Microscope Images of CSGAC (left) and BGAC (right).

The adsorption properties of both carbons were experimentally determined using a batch system with a specified amount of carbon. A solution of carbamazepine and sucrose in a 1 L beaker was placed on a stir plate, and a stir bar was added to mix the solution. For each experiment, a water sample was taken before activated carbon was added to measure the initial concentration. Once the experiment was running, samples were taken at designated times to determine the change in carbamazepine concentration over time. The experimental setup is shown in Figure 7.2.1.

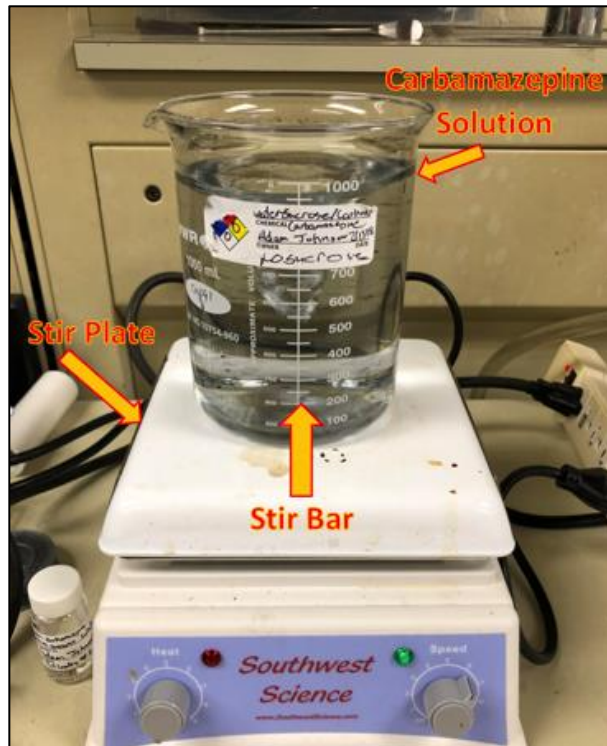

Figure 7.2.1 GAC Batch Adsorber

## 7.2.2 Carbon Loading Procedure and Results

To determine if CSGAC adsorbs carbamazepine effectively, a batch process was conducted. For this experiment, two 1 L solutions of 1 ppm carbamazepine were created. However, one solution contained 25 ppm sucrose, while the other did not have any sucrose. This was done to determine the effects of sucrose on carbamazepine adsorption. Once the mixture reached uniformity, a sample was taken to determine the initial concentration. Then, 2.5g of CSGAC was added to each batch process. After the addition of the CSGAC, samples were taken at 5, 10, 20, 40, 60, and 120 minutes. A pseudo-first and second order rate model were created to relate the adsorption rates of different carbamazepine solutions. It is important to note that for low concentrations of carbamazepine, the equilibrium concentration adsorbed to the GAC,  $q_e$ , can be assumed to be zero. In addition,  $q_t$  is the amount adsorbed to carbon at time t, and k is the rate constant. The rate constants for the pseudo-first order can be found by using the equation given by Langergen and Svenska<sup>[18]</sup>:

$$\ln(q_e - q_t) = \ln(q_e - kt) \quad (7.2.1)$$

$$q_e = \frac{[CBZ]_{int} - [CBZ]_{eq}}{m_{carbon}} \quad (7.2.2)$$

$$\text{For Low Starting Concentrations } [CBZ]_{eq} \sim 0 \quad (7.2.3)$$

$$q_e = \frac{[CBZ]_{int}}{m_{carbon}} \quad (7.2.4)$$

$$q_t = \frac{[CBZ]_{int} - [CBZ]_t}{m_{carbon}} \quad (7.2.5)$$

$$\ln \frac{[CBZ]_t}{m_{carbon}} = \ln \frac{[CBZ]_{int}}{m_{carbon}} - kt \quad (7.2.6)$$

$$\ln[CBZ]_t = \ln[CBZ]_{int} - kt \quad (7.2.7)$$

As seen in Figure 7.2.2, the model demonstrated a strong relation with pseudo-first order kinetics, producing an  $R^2$  value of 0.999 and 0.994 for the sucrose and without sucrose solutions, respectively. By graphing equation 7.2.7, using experimental data, the rate constant can be found by determining the slope of the line of best fit. The difference between the rates is statistically insignificant- supporting the fact that sucrose, especially at low concentrations, has little effect on the adsorption rates.

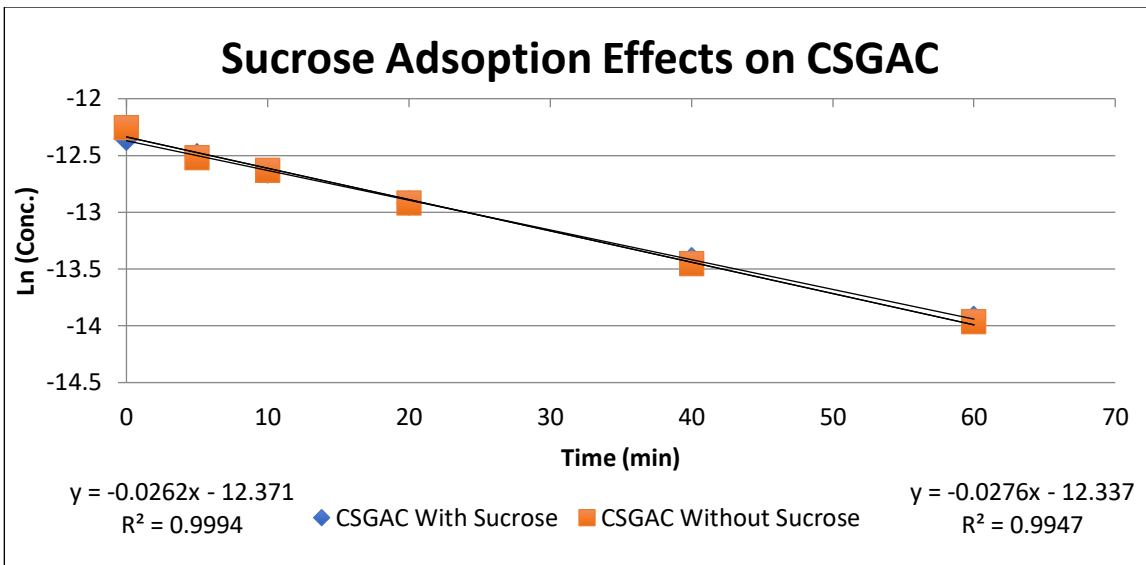

Figure 7.2.2: Pseudo-First Order Kinetics of a 1 ppm Carbamazepine and CSGAC Solution

To evaluate the relative adsorption capabilities of the CSGAC, BGAC was also tested. Once again, two batch processes were created to test the effectiveness of the BGAC, and the effects of sucrose on adsorption. Two 10 ppm carbamazepine solutions were created, while one contained 250 ppm sucrose and the other did not contain sucrose. As seen in Figure 7.2.3, the sucrose once again had minimal effect on carbamazepine adsorption. Furthermore, the rate constants produced by the BGAC were almost twice as high as those from the CSGAC.

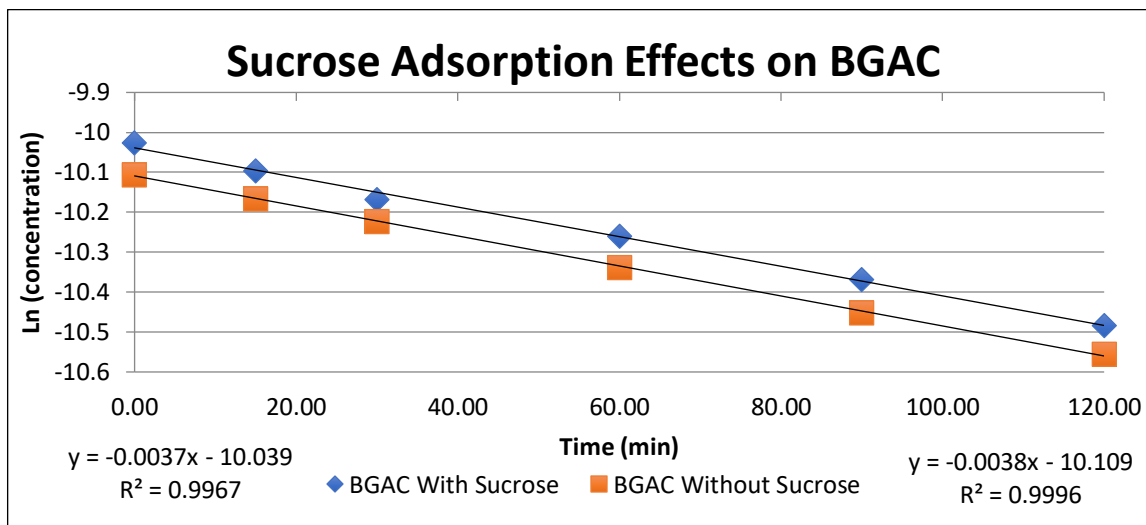

Figure 7.2.3: Pseudo-First Order Kinetics of a 10 ppm Carbamazepine BGAC Solution

For the final batch experiment, the total loading or loading capacity of the BGAC (mg CBZ/g carbon) was determined by using higher initial concentrations and allowing the system to approach equilibrium. Because of the higher concentrations used in this series of experiments,

the final concentration of carbamazepine could not be assumed to be zero and the full pseudo-first order equation given by Langergen and Svenska must be used.<sup>[18]</sup>

$$\ln(q_e - q_t) = \ln(q_e - kt) \quad (7.2.8)$$

Two experiments were conducted to establish the maximum amount of carbamazepine that BGAC adsorbs. The starting concentrations were 20 ppm and 100 ppm carbamazepine. The 20 ppm solution was able to adsorb to levels near detection limits, indicating that it was not fully loaded. The 100 ppm was able to reach an equilibrium concentration of 34 ppm, which is a capacity of 264 (mg CBZ/g carbon). Additionally, the rate equations continued to demonstrate a rate constant of 0.003 1/min.

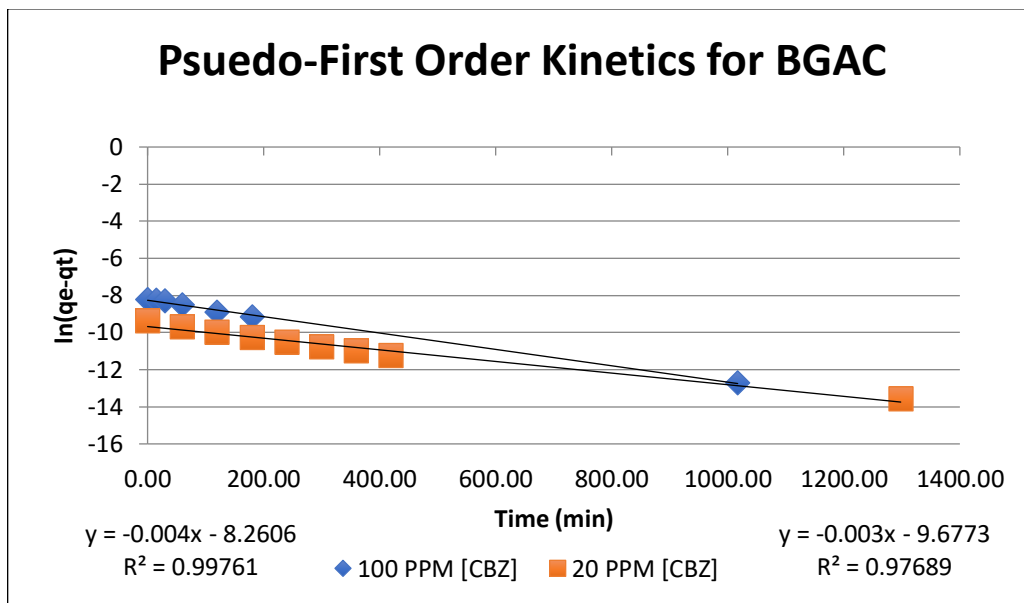

Figure 7.2.4: Pseudo-First Order Kinetics of a 20 ppm and 100 ppm Carbamazepine BGAC solution, with proportional concentrations of sucrose.

## 7.3 Packed Bed Experiment

### 7.3.1 Experimental Setup

The CSGAC and the BGAC were further tested in a packed bed to determine how effectively they removed carbamazepine at the maximum water flux generally achieved by a home GAC unit (based on 5 gallons per minute flowing through a 4 inch diameter filter). A diameter of 4 inches was chosen as the reference diameter because it is a common diameter for home-use filter housings. Based on this diameter and flow rate, an equivalent flux of 150 gpm/ft<sup>2</sup> for a bench scale system was achieved by using a 1 inch diameter bed flowing at 0.35 gpm. Six, 1 inch ID beds were constructed out of PVC; four were packed with CSGAC and two were

packed with BGAC. The experimental setup is shown in Figure 7.3.1 and as a PFD in 7.3.2 below.

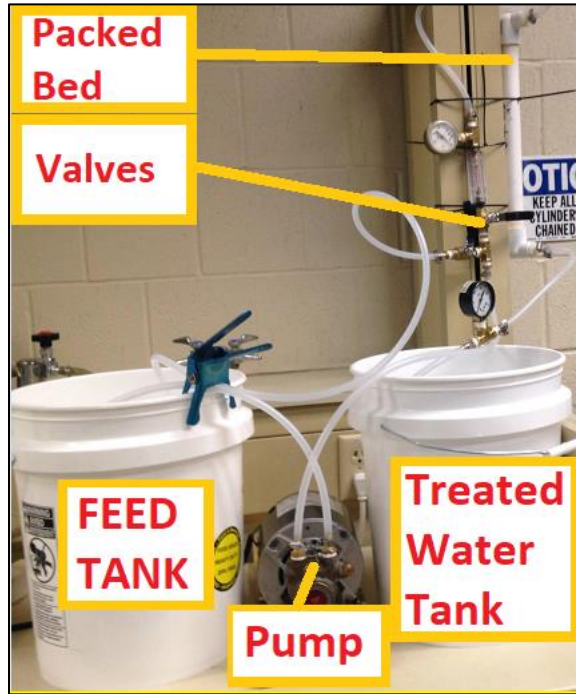

Figure 7.3.1: GAC Packed Bed Experimental Setup

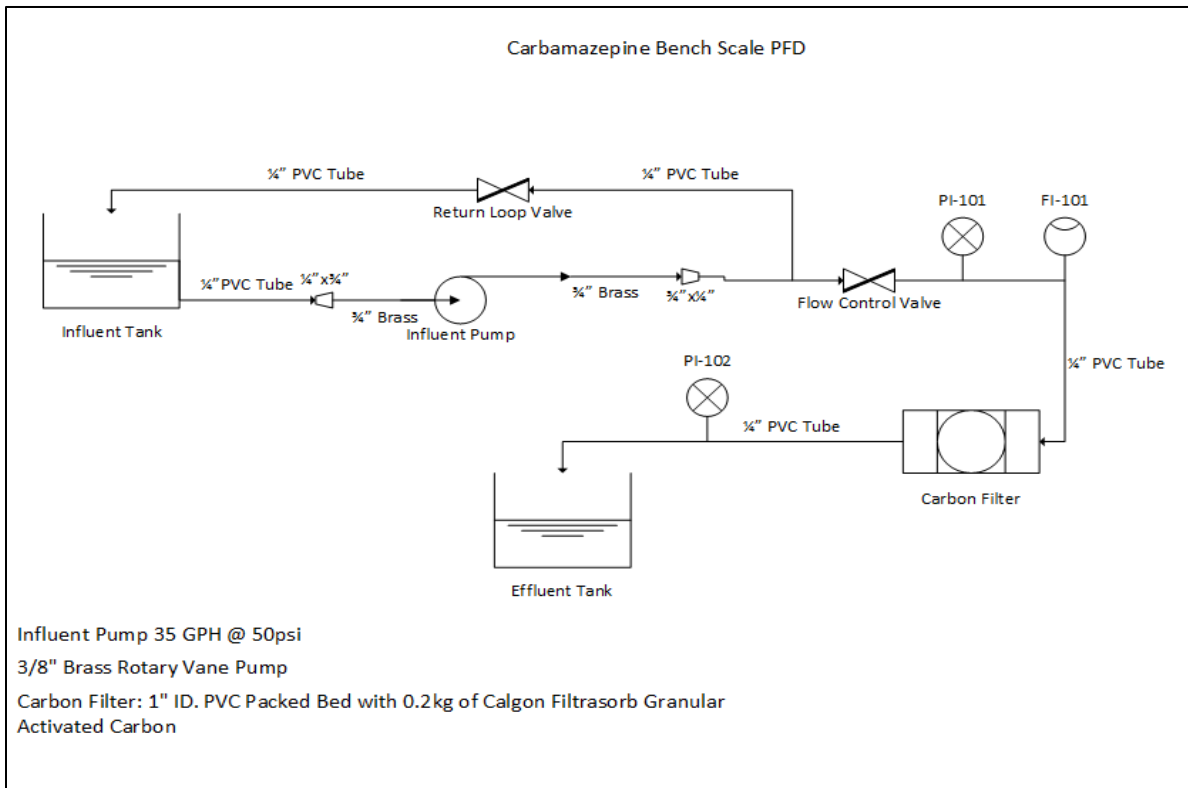

Figure 7.3.2 Packed Bed Process Flow Diagram

### 7.3.2 Packed Bed Procedure and Results

A stock solution (1 ppm carbamazepine, 25 ppm sucrose, using Milli-Q water) was created and placed into a five gallon feed tank where a sample of untreated water was taken for analysis. Untreated water was then pumped from the feed tank through the packed bed, and allowed to come to steady-state by passing 3 bed volumes of feed through the bed, and then sampled for analysis. Pressure and flow rate were monitored and controlled by altering the positions of both the feed and return valves to maintain the desired flux. This process was repeated for all six beds. After running each bed, the bed was detached and replaced by a new bed. The percent removal-results of each packed bed are shown below in Figure 7.3.3.

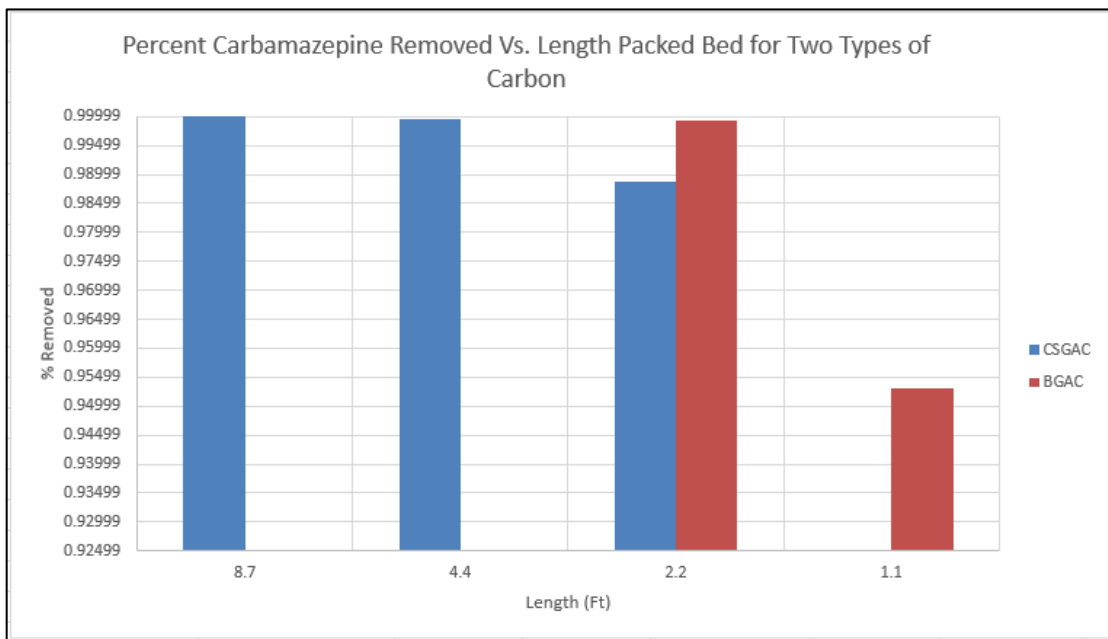

Figure 7.3.3: Length of Packed Bed Vs. Percent Removal for Carbamazepine

From this data, it is evident that the BGAC outperformed CSGAC at removing carbamazepine from feed water at the given conditions. In fact, CSGAC required approximately twice the volume of carbon to achieve the same removal. However, both carbons are effective at removing 99.9% of carbamazepine with negligible pressure drop. In addition, both carbons do not require an unreasonable amount of carbon to achieve the desired concentration.

### 8.0 BENCH SCALE PROCEDURE

- 1) Open all valves.
- 2) Turn on pump.
- 3) Adjust flow back valve to achieve desired flow rate.



4) Ensure influent tank has ample water.

## 9.0 INDUSTRIAL SCALE DESIGN

### 9.1 Ozone Oxidation Scale Up

To design a plug flow reactor (PFR) for ozone oxidation of carbamazepine, the kinetics from the second ozone experiment were used. To reiterate, the rate expression obtained from this experiment was as follows:

$$r = 0.5867[\text{CBZ}] \frac{\text{mol}}{\text{L} * \text{min}} \quad k = 0.5867 \frac{1}{\text{min}} \quad (9.1.1)$$

To estimate the volume of the plug flow reactor, perfect radial mixing, steady-state and constant density were assumed. The following equation was used to determine the volume of the PFR:

$$V = \int_0^X \frac{F_{Ao} dX}{-r_A} = F_{Ao} \int_0^X \frac{dX}{kC_A} = F_{Ao} \int_0^X \frac{dX}{kC_{Ao}(1-X)} = \frac{-F_{Ao}}{kC_{Ao}} (\ln(1 - X)) \quad (9.1.2)$$

Below, Table 8.1 lists the specifications used to solve for the volume of the PFR.

Table 8.1: Industrial Scale Plug Flow Reactor Specifications

Volumetric flow rate, $v_o$ (gal/min)	5
Initial concentration of CBZ (ppm)	1
Inlet flow rate of CBZ (mol/min)	$8.006 * 10^{-5}$
Rate constant (1/min)	0.5867
Conversion (%)	99.9

Using these values, the plug flow reactor volume needed for ozone oxidation of carbamazepine is 222.84 L (~223 L). POLYMATH was used to verify if the obtained volume was correct, and using this program, the volume of the plug reactor was calculated to be 223.64 L. The plug flow reactor volume for ozone oxidation a scale-up would be too large with the given criteria; thus, ozone oxidation was not chosen for a home scale unit.

## 9.2 Activated Carbon Adsorption Scale Up

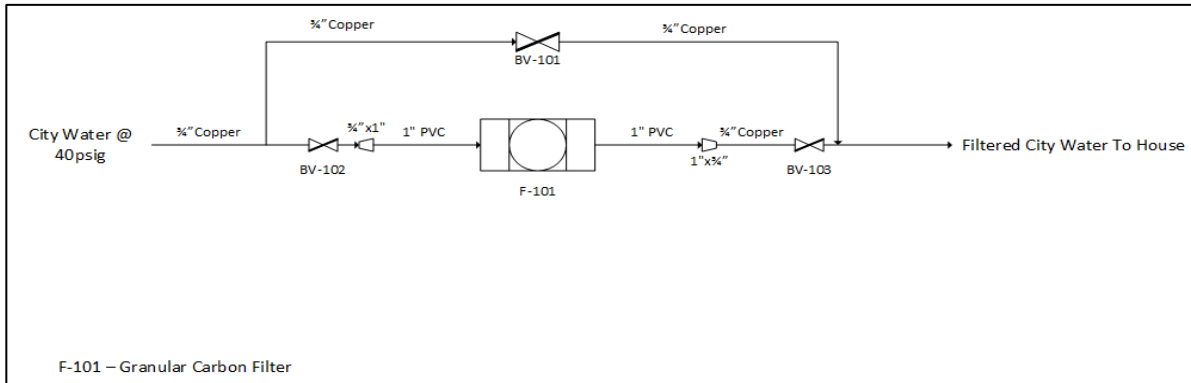

Figure 9.2.1 Home Unit Process Flow Diagram

The scaled-up home unit will be installed into the water inlet line to a house allowing for whole home filtration. To maintain water pressure in the house when filters are being changed, a bypass line can be opened before the filter is blocked in. The typical lines in a house are  $\frac{3}{4}$ " copper tubing and will require 2 reducer bushings to connect to the 1" connections on the filter housing.

### 10.0 ECONOMIC ANALYSIS

Using the results from the carbon loading experiments, a Freundlich Isotherm was developed using the equation below.  $C_e$  is the equilibrium concentration in solution in (mg/L),  $q_e$  is the mass adsorbed/mass of carbon in (mg/g), and  $K_f$  and  $1/n$  are the Freundlich constants.

$$q_e = K_f C_e^{1/n} \quad (10.1.1)$$

Table 10.1 Activated Carbon Capacities

	BGAC	CSGAC
$K_f$ (mg/g)(L/mg) <sup>1/n</sup>	17.52	4.301
1/n	0.5235	0.5887
Capacity at 1 ppm (mg/g)	17.52	4.301
Carbon use per year (lb/yr)	17.37	70.75

The isotherms, in Table 10.1 above, indicate that the BGAC has a capacity four times greater than the CSGAC. As a result, less carbon is required to reduce the carbamazepine concentration to 1 ppb. The isotherms are limited, though, since they are not accounting for the linear portion of the adsorption curve and true equilibrium. By not using final equilibrium data, the value of carbon capacity will be underestimated; however, it will ensure that the filters stay in a state

where they readily absorb carbon. Ultimately, basing the life of the filters on these models will provide a conservative estimate that could be further refined with more data.

Both types of carbon require the same system setup and will have similar costs. The housing system costs \$250 for three 20”x4.5” housings and bracket. Differences in cost would be the cost of the filters and the frequency at which they must be replaced. A CSGAC cartridge holds approximately 4lbs of carbon, so the total housing capacity would be 12lbs. From the data in Table 10.1, the filters would need to be replaced every 2 months at a yearly cost of \$589.68. The BGAC does not come in prebuilt units and requires different steps than the CSGAC cartridge. Because the carbon casing must be emptied and refilled, the replacement of carbon will be more hands on than simply replacing an entire CSGAC cartridge. Three refillable casings are required for BGAC and can hold 6lbs of carbon each. This brings the total amount of carbon to 18lbs and could sustain removal for a year before needing to be replaced. A 35lb bag of BGAC costs \$180 and will last 2 years; that is \$90 a year to maintain the unit.

In total, the CSGAC system would cost \$990 for the first year and \$589.68 for each following year. The BGAC system would cost \$639 for the first two years, and then \$200 every two years following the initial capital investment.

## **11.0 HEALTH AND ENVIRONMENTAL CONCERNS**

Although research has been conducted over the past decade on concentration levels of various pharmaceuticals in source water and drinking water, there is limited data to determine the potential health risks. The WHO concluded from three case studies that even though pharmaceuticals, such as carbamazepine, are detected in drinking water, concentration levels (even at the highest reported concentration) are 1000 fold below the acceptable daily intake (AID) or minimum therapeutic dose (MTD).<sup>[1]</sup> Currently, the EPA has not implemented regulations of carbamazepine. The general public is not adequately informed of possible health effects from carbamazepine; thus, there is a concern for sensitive populations such as people who have allergies, people who take drugs that cannot be mixed with other drugs, pregnant women, children, and elders.<sup>[19]</sup>

Public health is not the only concern; the environment is also affected by the presence of carbamazepine in source water and drinking water if the concentration of carbamazepine were to exceed the MTD. Water contaminated with carbamazepine used for industrial purposes, such as farming, can reach other organisms. A study, conducted by Franklin et al., showed that wheat

grain did contain carbamazepine; however, the concentration was considerably low (ng/g) to cause a potential health threat. Furthermore, carbamazepine was most likely accumulated during its maturity stage.<sup>[20]</sup> Another study, performed by Dordio et al., showed that a metabolite of carbamazepine was present in Typha plants. Dordio et al., proposed that the presence of the metabolite exemplifies that degradation of carbamazepine occurs within the plant during its development stage. This proposal could explain why the wheat grain and typha plants contained a low concentration of carbamazepine. The accumulation of carbamazepine in these plants could also be due to lack of moisture in their maturity stage.<sup>[20],[21]</sup> From these studies, it is important to consider future removal of carbamazepine to mitigate human health and environmental effects.

## **12.0 REGULATIONS AND FUTURE IMPACTS**

Currently, there are no EPA regulations on carbamazepine levels in drinking water or wastewater treatment plants. However; regulations have been implemented in Minnesota. The Minnesota Department of Health set a guidance value of 40 ppb for drinking water, which is significantly greater than the concentration of carbamazepine reported in various water sources.<sup>[22]</sup> While there are no country wide regulations today, it is believed that there will be regulations put in place in the next few years.

If regulations are enacted in the future to demand drinking water facilities to remove carbamazepine, there can be an impact on the capability of companies meeting the requirements depending on how low the concentration limit is set. Larry Lloyd, PE., the Chief Operating Officer from the Beaver Water District facility in Lowell, AR, was asked on the future implications of pharmaceutical regulations. From Lloyd's statement, drinking water facilities could potentially not meet the requirements since it would be costly to implement treatment methods if only a small percentage of treated water is used for human consumption. If drinking water facilities do implement new treatment methods, it could be possible that the water bill for homeowners will increase, so facilities could cover the costs of the added treatment methods.

Another future implication from the implementation of regulation could be how contaminated water is treated. Ozone oxidation does degrade carbamazepine, however, the effects of the by-products are not known. This a health concern since the by-products could be more harmful than carbamazepine. If future regulations are implemented, water treatment facilities will have to consider the potential health effects of by-products formed in certain

treatment methods. Granular activated carbon is an ideal removal method because degradation products are not produced.

### **13.0 CONCLUSIONS AND RECOMMENDATIONS**

Before regulations are enacted, more research on the potential health effects of carbamazepine must be conducted. Once regulations have been implemented, water treatment facilities will have to remove carbamazepine without endangering consumers from harmful by-products and without affecting the facility and consumers economically. Lloyd proposed that a potential solution would be for drinking water facilities or local stores, such as Lowes or Home Depot, to sell home units that are adequately designed to remove pharmaceuticals. This solution would demand an upfront cost for consumers and occasional maintenance costs; however, there could be economic incentives as it would prevent an increase in treatment costs at the plant.

### **14.0 ACKNOWLEDGEMENTS**

The authors would like to thank the following individuals for their help and guidance: Dr. Tammy Lutz-Rechtin; Dr. Jackson Lay and Dr. Jennifer Gidden from the Arkansas Statewide Mass Spectrometry Facility; Dr. Clinton Williams from the USDA; Mark Peet and Eric Forrester from the Calgon Carbon Corporation; Larry S. Lloyd from The Beaver Water District; The Arkansas Alpha Chapter of Tau Beta Pi; Dr. Mourad Benamara and Dr. Betty Martin from The University of Arkansas Institute for Nanoscience and Engineering; Becky Keogh from the Arkansas Department of Environmental Quality. Part of this work was done in the Arkansas Statewide Mass Spectrometry Facility, supported by Grant Number P30 GM103450 from the National Institute of General Medical Sciences of the National Institutes of Health (NIH).

### **15.0 REFERENCES**

- [1] “Pharmaceuticals in Drinking Water.” *Who.int*, World Health Organization (WHO), 2011, [www.who.int/water\\_sanitation\\_health/publications/2011/pharmaceuticals\\_20110601.pdf](http://www.who.int/water_sanitation_health/publications/2011/pharmaceuticals_20110601.pdf).
- [2] “Carbamazepine.” *Drugs.com*, Drugs.com, [www.drugs.com/carbamazepine.html](http://www.drugs.com/carbamazepine.html).
- [3] Luo, Yunlong, et al. “A Review on the Occurrence of Micropollutants in the Aquatic Environment and Their Fate and Removal during Wastewater Treatment.” *Science of The Total Environment*, vol. 473-474, 1 Mar. 2014, pp. 619–641., doi:10.1016/j.scitotenv.2013.12.065.
- [4] Kasprzyk-Hordern, Barbara, et al. “The Removal of Pharmaceuticals, Personal Care Products, Endocrine Disruptors and Illicit Drugs during Wastewater Treatment and Its Impact on the Quality of Receiving Waters.” *Water Research*, vol. 43, no. 2, Feb. 2009, pp. 363–380., doi:10.1016/j.watres.2008.10.047.

- [5] Matamoros, Víctor, and Victòria Salvadó. “Evaluation of a Coagulation/Flocculation-Lamellar Clarifier and Filtration-UV-Chlorination Reactor for Removing Emerging Contaminants at Full-Scale Wastewater Treatment Plants in Spain.” *Journal of Environmental Management*, vol. 117, 15 Mar. 2013, pp. 96–102., doi:10.1016/j.jenvman.2012.12.021.
- [6] Röhricht, Markus, et al. “Elimination of Carbamazepine, Diclofenac and Naproxen from Treated Wastewater by Nanofiltration.” *CLEAN - Soil, Air, Water*, vol. 37, no. 8, 1 Aug. 2009, pp. 638–641., doi:10.1002/clen.200900040.
- [7] Trinh, T., et al. “Removal of Trace Organic Chemical Contaminants by a Membrane Bioreactor.” *Water Science & Technology*, vol. 66, no. 9, Aug. 2012, pp. 1856–1863., doi:10.2166/wst.2012.374.
- [8] “Water Treatability Database.” *Iaspub.epa.gov*, Environmental Protection Agency (EPA), 5 Feb. 2007, iaspub.epa.gov/tdb/pages/treatment/treatmentOverview.do?treatmentProcessId=2109700949.
- [9] Suriyanon, Nakorn, et al. “Mechanistic Study of Diclofenac and Carbamazepine Adsorption on Functionalized Silica-Based Porous Materials.” *Chemical Engineering Journal*, vol. 214, 1 Jan. 2013, pp. 208–218., doi:10.1016/j.cej.2012.10.052.
- [10] McDowell, Derek C., et al. “Ozonation of Carbamazepine in Drinking Water: Identification and Kinetic Study of Major Oxidation Products.” *Environmental Science & Technology*, vol. 39, no. 20, 2005, pp. 8014–8022., doi:10.1021/es0500431
- [11] Kim, Sang D., et al. “Occurrence and Removal of Pharmaceuticals and Endocrine Disruptors in South Korean Surface, Drinking, and Waste Waters.” *Water Research*, vol. 41, no. 5, Mar. 2007, pp. 1013–1021., doi:10.1016/j.watres.2006.06.034.
- [12] Rushing, Blake, et al. “Comparison of LC–MS and GC–MS for the Analysis of Pharmaceuticals and Personal Care Products in Surface Water and Treated Wastewaters.” *Current Trends in Mass Spectrometry*, vol. 14, no. 3, 1 July 2016, pp. 8–14., www.researchgate.net/publication/313075285\_Comparison\_of\_LC-MS\_and\_GC-MS\_for\_the\_Analysis\_of\_Pharmaceuticals\_and\_Personal\_Care\_Products\_in\_Surface\_Water\_and\_Treated\_Wastewaters.
- [13] Batt, Angela L., et al. “Analysis of Ecologically Relevant Pharmaceuticals in Wastewater and Surface Water Using Selective Solid-Phase Extraction and UPLC-’MS/MS.” *Analytical Chemistry*, vol. 80, no. 13, 23 May 2008, pp. 5021–5030., doi:10.1021/ac800066n.
- [14] “Method 1694: Pharmaceuticals and Personal Care Products in Water, Soil, Sediment, and Biosolids by HPLC/MS/MS .” *Epa.gov*, Environmental Protection Agency (EPA), Dec. 2007, www.epa.gov/sites/production/files/2015-10/documents/method\_1694\_2007.pdf.
- [15] “Method 542: Determination of Pharmaceuticals and Personal Care Products in Drinking Water by Solid Phase Extraction and Liquid Chromatography Electrospray Ionization Tandem Mass Spectrometry (LC/ESI-MS/MS).” *Epa.gov*, Environmental Protection

- Agency (EPA), [www.epa.gov/sites/production/files/2016-09/documents/method-542-determination-pharmaceuticals-personal-care-products-drinking-water.pdf](http://www.epa.gov/sites/production/files/2016-09/documents/method-542-determination-pharmaceuticals-personal-care-products-drinking-water.pdf).
- [16] “Product Information: Carbamazepine.” *Sigmaaldrich.com*, Sigma, [www.sigmaaldrich.com/content/dam/sigma-aldrich/docs/Sigma-Aldrich/Datasheet/c1037-22k8805fdat.pdf](http://www.sigmaaldrich.com/content/dam/sigma-aldrich/docs/Sigma-Aldrich/Datasheet/c1037-22k8805fdat.pdf).
- [17] “Raw Materials of Activated Carbon.” *Desotec.com*, Desotec, [www.desotec.com/en/carbonology/carbonology-academy/raw-materials-activated-carbon](http://www.desotec.com/en/carbonology/carbonology-academy/raw-materials-activated-carbon).
- [18] Hameed, B, et al. “Adsorption of Methylene Blue onto Bamboo-Based Activated Carbon: Kinetics and Equilibrium Studies.” *Journal of Hazardous Materials*, vol. 141, no. 3, 22 Mar. 2007, pp. 819–825., doi:10.1016/j.jhazmat.2006.07.049.
- [19] Lam, Steven. “Health Effects of Pharmaceuticals in the Water Supply: A Knowledge Synthesis.” *Ncceh.ca*, University of Guelph, 6 Mar. 2014, [www.ncceh.ca/sites/default/files/Guelph-Lam-2014.pdf](http://www.ncceh.ca/sites/default/files/Guelph-Lam-2014.pdf).
- [20] Franklin, Alison M., et al. “Uptake of Three Antibiotics and an Antiepileptic Drug by Wheat Crops Spray Irrigated with Wastewater Treatment Plant Effluent.” *Journal of Environment Quality*, vol. 45, no. 2, 1 Mar. 2016, pp. 546–554., doi:10.2134/jeq2015.05.0257.
- [21] Dordio, A.V., et al. “Evaluation of Carbamazepine Uptake and Metabolization by Typha Spp., a Plant with Potential Use in Phytotreatment.” *Bioresource Technology*, vol. 102, no. 17, Oct. 2011, pp. 7827–7834., doi:10.1016/j.biortech.2011.06.050.
- [22] “Carbamazepine in Drinking Water .” *Health.state.mn.us*, The Minnesota Department of Health (MDH) , Aug. 2011, [www.health.state.mn.us/divs/eh/risk/guidance/dwec/carbamazeinfo.pdf](http://www.health.state.mn.us/divs/eh/risk/guidance/dwec/carbamazeinfo.pdf).

Audit from Ms. Becky Keogh: Director of the Arkansas Department of Environmental Quality

Overall quality, thoroughness, technical depth and clarity:

The project team has done an excellent job in conducting the task and has demonstrated a broad and encompassing understanding of the problem and the research conducted. The report provides clear and effective communication of work performed and results obtained. In the spirit of continuous improvement, I offer the following observations and comments on the individual judging criteria and report sections:

Quality and clarity of Executive Summary:

The summary provides a clear and concise statement of objectives, work performed, and findings. As stated, the topic of emerging contaminants in rivers and streams, particularly those which can potentially affect current or future drinking water resources is top priority for state environmental and health leaders across our country. Some states have already begun regulatory action while others have supported or are involved in ongoing research through our national associations as well as partner research boards,

Engineering and scientific basis:

The report and research conducted includes a look at reasonable and cost effective technology solutions for the consumer. The team has used proven and sound engineering technologies as a basis for this effort.

Equipment and process selection:

The equipment and process selected utilizes readily available materials. Considerations of existing infrastructure and home construction is a critical consideration as indicated in Section 9 of the report. Regional and local differences in construction standards and water utilities is a consideration when designing a consumer based solution

Discussion of legal, health and worker safety:

This process is an in-line technology. Safety considerations would be appropriate in the training of qualified contractors to change the inlet water filters. Public health and environment concerns and benefits are addressed in the report

Discussion of process monitoring:

The report clearly describes appropriate monitoring and metrics to define project effectiveness.

Discussion of bench-scale results, testing and evaluation:



Success of innovation relies on sound and well executed testing prior to full implementation. The project team designed a bench scaled demonstration which illustrates the technology . The bench scale and possible further pilot tests can be instrumental in definition of any practical considerations for larger scale development.

#### Economic analysis:

An economic analysis demonstrates a cost effective home based solution. While upfront costs to consumers are identified, those can be offset in savings. Economic incentives can be offered to expand or provide direct access to the technology through grants or technical assistance by government, water utilities, and consumer organizations.

#### Public involvement:

This study reflects technology solutions due to ongoing public concerns about emerging contaminants in water resources. The use of home based technologies allow for faster deployment and improved outcomes for the consumer, irrespective of water source or provider. Longer term solutions at the utility level can offer sustainable solutions.

Review of Task #5 Submission from Dr. Robert Beitle of the Ralph E. Martin  
Department of Chemical Engineering

The students have found a possible solution to the removal of carbamazepine from drinking water, namely the use of activated carbon to adsorb the contaminant. According to the report, students were to gather preliminary data to treat 8 gallons in a 2 hour period, and use this and other properties to develop a minimal energy intensive solution capable of treating 100 gallons per day.

The format of the report is somewhat cumbersome and presents two treatment options – ozone and adsorption, respectively. It is unclear why one would dedicate approximately four pages to the failure (ozone treatment), but would be justified if the overall judging takes into consideration the entire package of student effort.

Returning to the proposed solution, namely the design of an activated carbon (AC) adsorption system, the students did a good job in insuring they could measure ppm levels of carbamazepine, and provided experimental data for batch adsorption. After confirming batch adsorption would follow the expected kinetic trend, it would have been helpful to provide more equilibrium data to confirm the correct adsorption isotherm (Freundlich). They have the correct model and should add more data (if permitted) to insure the capacity estimates are reasonable. There is little detail regarding the physical and chemical properties of the AC, especially those related to bed design, and it is unclear if the benchtop system can treat 8 gallons in 2 hours. Additionally, there is no estimate of the energy requirements of the full scale model. This energy estimate must be completed before the competition.

I am very concerned that the students completed an economic analysis with faulty price data and design basis. The cost of AC is highly variable, as is the adsorption capacity of commercially available materials. Screening vendor data / literature for adsorption data of carbamazepine or similar monocyclic compounds (antibiotics, for example) could point to lower cost ACs with reasonable capacities. Put another way, merely examining two AC for efficacy without a strong justification (for the two) opens the solution to quick dismissal. Also, the basis for the design may be misleading. Most AC home filtration systems have smaller design requirements, for a human consumes 2 – 4 liters of water per day. A challenge of 100 gallons / day is very different from customary thinking (why do I care if my clothes are in contact with carbamazepine?, or is their toxicological data that indicate the drug adsorbs through my skin?). It must be made clear that the students are treating a very large amount of water, and if this frame of reference is correct, one can begin to take comfort in their design.

Health and safety are adequately addressed.

Regards,

Robert R. Beitle PhD PE  
AR #9530