

University of Arkansas, Fayetteville

ScholarWorks@UARK

---

Chemical Engineering Undergraduate Honors  
Theses

Chemical Engineering

---

5-2020

## Solution to Exide Technologies Inbatec Inefficiency

Reagan Gilker

*University of Arkansas, Fayetteville*

Mary Fairley

*University of Arkansas, Fayetteville*

Spencer Christain

*University of Arkansas, Fayetteville*

Shixuan Hou

*University of Arkansas, Fayetteville*

Covenson Latouche

*University of Arkansas, Fayetteville*

Follow this and additional works at: <https://scholarworks.uark.edu/cheguht>

 Part of the [Other Chemical Engineering Commons](#)

---

### Citation

Gilker, R., Fairley, M., Christain, S., Hou, S., & Latouche, C. (2020). Solution to Exide Technologies Inbatec Inefficiency. *Chemical Engineering Undergraduate Honors Theses* Retrieved from <https://scholarworks.uark.edu/cheguht/169>

This Thesis is brought to you for free and open access by the Chemical Engineering at ScholarWorks@UARK. It has been accepted for inclusion in Chemical Engineering Undergraduate Honors Theses by an authorized administrator of ScholarWorks@UARK. For more information, please contact [scholar@uark.edu](mailto:scholar@uark.edu).

Solution to Exide Technologies Inbatec Inefficiency

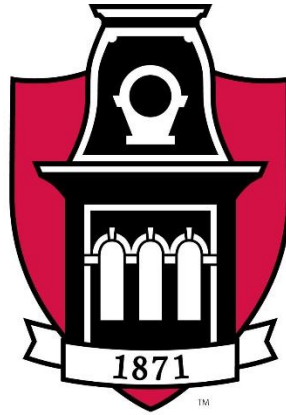

# UNIVERSITY OF ARKANSAS

**College of Engineering**

Ralph E. Martin Department of Chemical Engineering

Spencer Christian

Mary Kate Fairley

Reagan Gilker

Shixuan Hou

Covenson Latouche

# Table of Contents

<b>Executive Summary</b> .....	2
<b>Introduction</b> .....	3
<b>Exide Technologies: Fort Smith</b> .....	3
<b>Purpose and Objective</b> .....	3
<b>Process Description</b> .....	3
<b>Initial Fill Process</b> .....	5
<b>Charging Process</b> .....	5
<b>Results</b> .....	6
<b>Proposed Modifications</b> .....	6
<b>Design Basis Data</b> .....	7
<b>Economic Analysis</b> .....	7
<b>Discussion</b> .....	8
<b>Conclusions</b> .....	9
<b>Recommendations</b> .....	9
<b>Appendix</b> .....	10
<b>Appendix A: Pump Curve</b> .....	10
<b>Appendix B: Method for Determining the Head Loss from the Proposed Modification</b> .....	11
<b>Appendix C: Method for Determining Time Saved for Unit 1</b> .....	12
<b>Appendix D: Method for Determining Additional Revenue for Unit 1</b> .....	12
<b>Appendix E: Method for Determining Additional Energy Expenses</b> .....	13
<b>Appendix F: Cost of Bypass Line Implementation</b> .....	13
<b>References</b> .....	14
<b>Personal Contribution: Reagan Gilker</b> .....	15

## **Executive Summary**

The inefficiency of the battery charging time in Inbatec Units 1 and 2 in the Exide Technologies Fort Smith was initially investigated by a student team in Fall 2019, and the investigation was continued into Spring 2020. The Exide Technologies facility in Fort Smith, Arkansas utilizes 13 Inbatec units to charge the lead-acid batteries.

The Inbatec systems circulate the sulfuric acid solution through a cooling tower to maintain to optimal charging temperature. Previous analysis of the charging process for Inbatec Units 1 and 2 show the cooling tower have the capacity to quickly remove the excess heat in the sulfuric acid solution and to reduce the solution temperature to 120°F. As a result of the Fall 2019 student team, the Spring 2020 Exide Student Team was able to identify the source of the battery charging inefficiency. However, the control scheme of the Inbatec units prevent a constant flowrate to the top of the cooling tower.

The recommended modification to the Inbatec Unit 1 is to change the control scheme of Y05. The movement of the pneumatic valve Y05 is hardwired into the Inbatec system and is unable to be altered. Therefore, the modifications to test the solution are as follows: the installation of a bypass (Stream B) around valve Y05 and an increased flowrate throughout the system.

The estimated investment is approximately \$283. The implementation of the bypass valve in Unit 1 will save Exide Technologies approximately 1,495 battery charging hours annually. The time saved could be used to charge 265 additional batteries, generating an additional \$479,120 per year in revenue for Inbatec Unit 1. If the bypass were implemented in both units, the number of batteries that could be charged in the saved time would be doubled and the design modification would generate \$958,240 in revenue annually.

## **Introduction**

### **Exide Technologies: Fort Smith**

Exide Technologies is a lead-acid battery manufacturing company, which specializes in the manufacturing of automotive and industrial batteries. The Exide Technologies facility in Fort Smith, Arkansas utilizes 13 Inbatec units to charge the lead-acid batteries. The Inbatec systems circulate the sulfuric acid solution through a cooling tower to maintain to optimal charging temperature.

The optimal temperature to charge the lead-acid KDZ batteries is between 120°F and 130°F. At temperatures below 120°F, the oxidation reaction occurs at a slower rate, charging the batteries slowly. At temperatures above 130°F, the oxidation reaction will occur too quickly causing an excess of reaction off-gases and potentially damaging the batteries.

For this reason, current to the batteries will be shut off when an acid temperature of 130°F is reached. The current supply does not resume until the acid solution is cooled to a temperature of 120°F. The acid cooling time significantly increases the battery charging process time.

Inbatec Units 1 and 2, which charge the KDZ batteries used to start locomotive vehicles, charge fewer batteries in the same profile time compared to Units 3-13. Units 1 and 2 are older models of the Inbatec technology. The older models of the Inbatec technology have 40 fewer hoses to connect to the batteries and lack a chiller to cool the acid solution before it is circulated through the system.

### **Purpose and Objective**

The purpose of the investigation into Exide Technologies' Inbatec Unit 1 was to identify the source of the battery charging time inefficiency, to design to a solution to the battery charging inefficiency, and to perform a cost analysis of the proposed solution.

### **Process Description**

The process flow diagram of Exide Technologies' Inbatec Unit 1 is shown in Figure 1. The Inbatec process has two functions: acid filling and battery charging. The acid filling process prepares the Inbatec Unit for battery charging by filling the acid fill tank (B02) with sulfuric acid solution at the target density of 1.12 kg/L. The battery charging process charges the batteries by supplying direct current by the rectifier. The flow of the sulfuric acid through the working tower (B01) is cooled by mixing with ambient air and by the evaporation water.

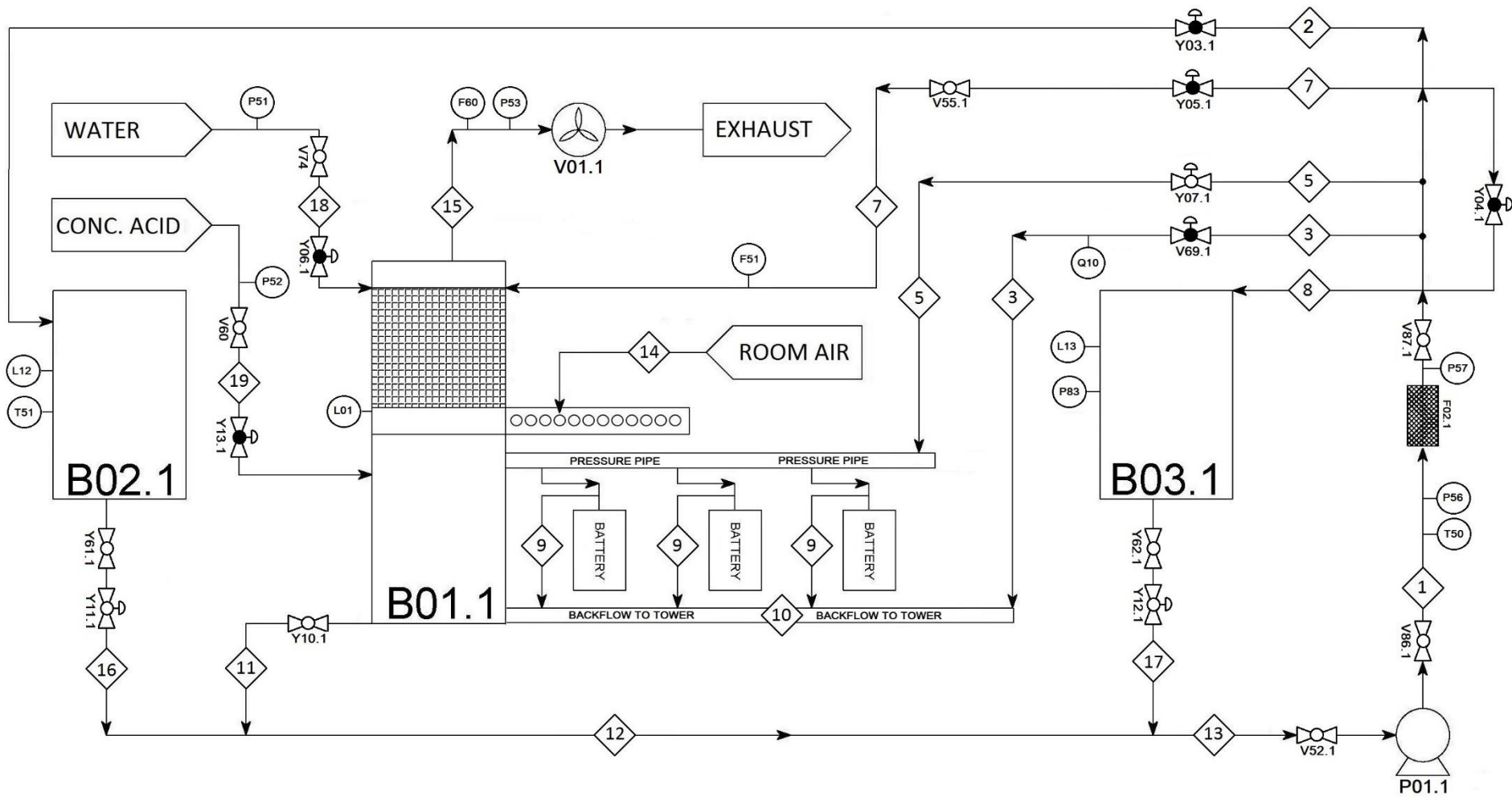

Figure 1. Process Flow Diagram of Inbatec Unit 1

### **Initial Fill Process**

To start the initial acid fill process, all valves shown in Figure 1 need to be closed. The exhaust fan (V01) is turned on, pulling the ambient air into the working tower (B01) and out through stream 15. The working tower is a packed bed cooling tower, whose function is to cool the sulfuric acid solution. At the bottom portion of the working tower is a tank where the acid solution can be stored. The valve on stream 18 is opened to allow water into the working tank. A valve is opened to allow flow to the pump (P01). The valves on streams 3 and 5 are opened. The pump is then turned on and water is pulled through streams 1, 3 and 5 and back into working tank. tower. While the water is circulating through the system, the valve on stream 18 is opened to allow the flow of the concentrated sulfuric acid (98 wt%) into the working tower where it will be mixed with the water already in the system. Once the density meter on stream 3 (Q10) reads a density of 1.12kg/L for the sulfuric acid solution, no more concentrated sulfuric acid will be added to the system. The valves leading to the working tower will be closed. The valves on stream 3 and 5 are closed, and the valve on stream 2 is opened so that the sulfuric acid solution can be pumped from the working tower to the fill acid tank (B02). When the working tower is empty, the exhaust fan and pump will be turned off. The remaining open valves on stream 11 and 2 are closed. These steps can be repeated until the fill acid tank is full and the battery charging process can begin.

If there is sufficient acid solution in final acid tank (B03) from previous battery charging, the initial fill process can be shortened. The valve on stream 17 can be opened and sulfuric acid in the final acid tank can be fed into stream 13 until the acid solution reaches the target density of 1.12 kg/L. Valves leading to the working tower will be closed, and the valve on stream 2 is opened so the sulfuric acid solution can be pumped from the working tower to the fill acid tank. When the working tower is empty, the exhaust fan and pump. From this point, the battery charging process can begin.

### **Charging Process**

Once enough sulfuric acid (1.12 kg/L of density) is in the fill tank to start the battery charging process, the pump and exhaust fan are turned on. The valve on stream 16 is opened to allow the sulfuric acid solution to flow from the fill acid tank to the working tower. The acid solution passes through a filter and stream 5 and enters the pressure pipe, where the solution flows into the batteries. After circulating through the batteries, the acid solution flows into the backflow pipe and into working tower. The acid solution collects at the bottom of the working tower and is circulated back to the pump.

The temperature of the acid solution is continuously monitored by a temperature sensor (T50) at the pump discharge. As the batteries charge, they heat up, causing the acid solution temperature to rise. When T50 indicates an acid solution temperature of 130°F, the valve that allows flow to the top of working tank to be cooled, the working tower (Y05) begins to open. When Y05 is fully open, the flowrate of stream 7 is about 50 L/min. The acid solution in stream 7 sprays through a

nozzle over packing, where heat from the acid solution is removed from evaporation and the heat exchange with ambient air that is pulled into the working tower by the fan. The cooled acid solution then collects at the bottom of the working tower, where it combines with the acid solution leaving the batteries. The combined contents of the working tower are pumped back through the pump and the system where T50 measures the temperature of the acid solution. When T50 indicates an acid solution temperature of less than 130°F, Y05 begins to close.

## Results

### Proposed Modifications

The objective of the proposed modifications to Inbatec Unit 1 is to reach a steady state where the acid solution temperature remains under 130°F and the rectifier supplies continuous current to the batteries. Changing the control scheme of Y05, which controls the flowrate of acid solution to the top of the working tower, would be the easiest solution, but the movements of the pneumatic valve are hardwired into the Inbatec system and are unable to be altered.

To test the proposed solution a bypass line around the pneumatic valve Y05 is recommended. The bypass line would be made of roughly 2 feet of 32 mm diameter polyethylene piping with a 32 mm manual diaphragm valve. There would be two elbows and two tees to connect the bypass to the existing system. The proposed bypass from the view of the is shown as green piping in Figure 2. The proposed bypass line on the Process Flow Diagram (PFD) is shown in Figure 3.

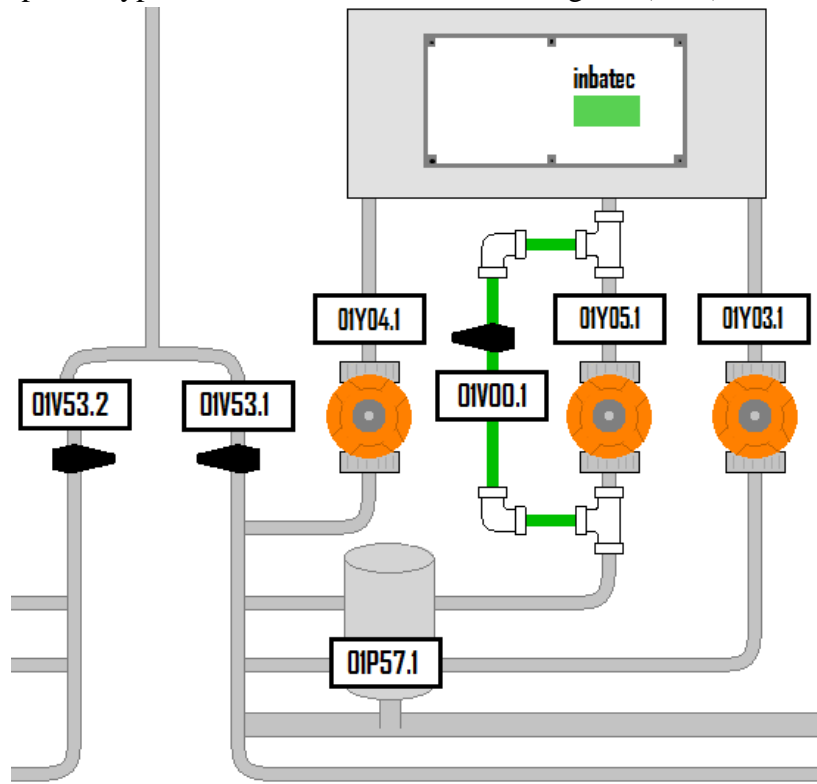

Figure 2. Proposed modification of Inbatec Unit 1.



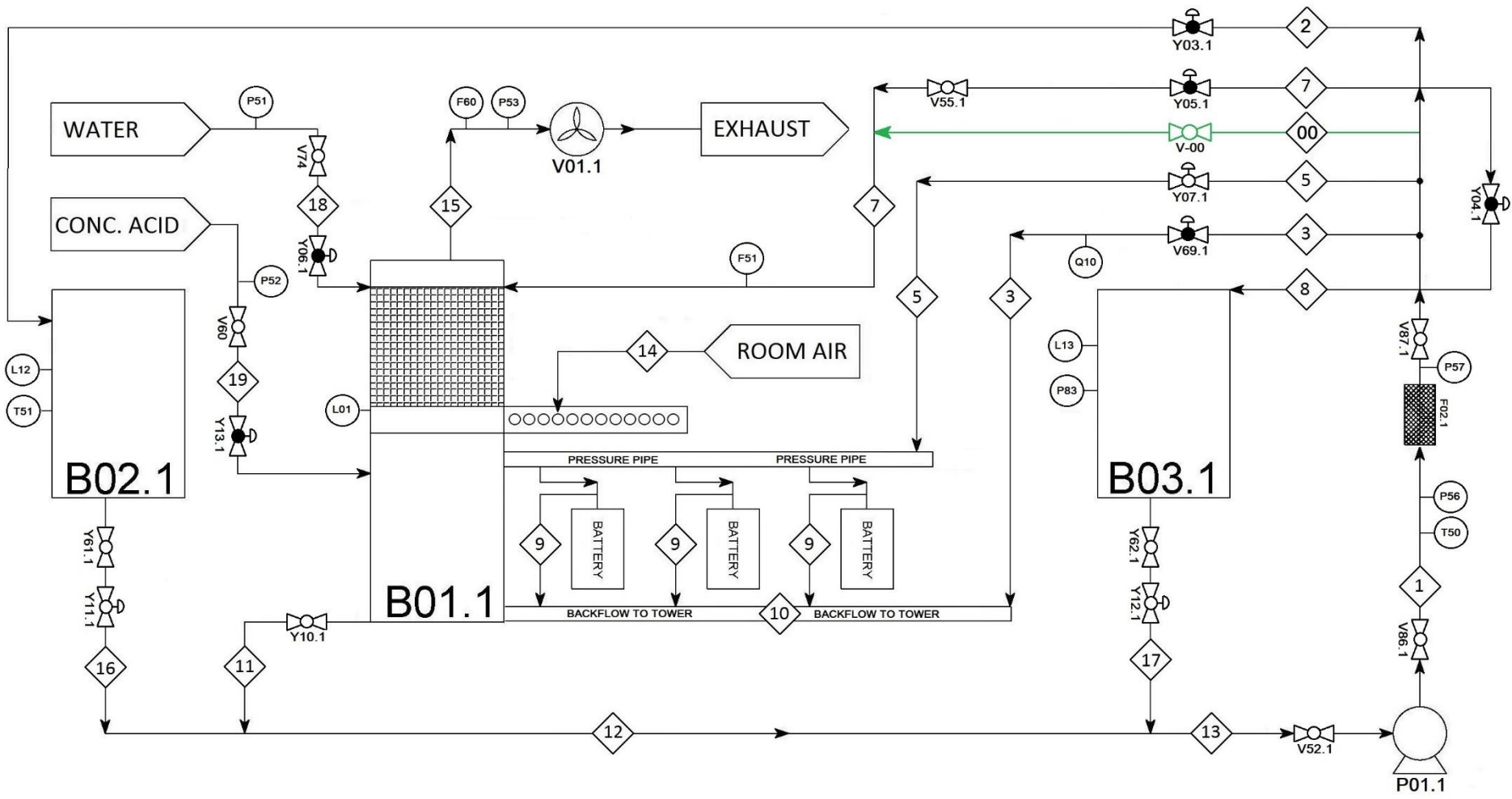

Figure 3. Process Flow Diagram for Inbatec Unit 1 showing bypass line.

## Design Basis Data

Aspen Plus was used to model the necessary acid solution flowrates to the top of the working tower (stream B) to maintain the solution temperature below 130°F. The model assumes the batteries increase the sulfuric acid solution temperature by 15°F. Therefore, the temperature indicator must read  $\leq 115$  °F. The results of the Aspen Plus model are shown in Table 1.

Table 1. Stream B Flowrate at Various Ambient Air Temperatures

<b>Ambient Air Temperature (°F)</b>	<b>Stream B Flowrate (L/min)</b>	<b>Total flow (L/min)</b>	<b>Temperature of T50 (°F)</b>
130	200	440	115.8
100	150	390	115
70	125	365	111

The pump curve in Appendix A was used to determine the head loss of the system. At the current recommended flowrate (300 L/min), there is 15.48 meters of head loss for this pump model. At the proposed maximum flowrate (440 L/min), there is approximately 14 meters of head loss.

The proposed bypass line would create 5.57 meters of head loss, which is well within the 14 meters of head loss the pump can handle. The calculations for the head loss created by the bypass line can be found in Appendix B.

## Economic Analysis

To determine the money saved with the implementation of the bypass around valve Y05, the KDZ-501 battery charging data with acid temperature versus time for July and December was used. The time the rectifier is off during a charging process was calculated by measuring the time elapsed between the rectifier shutoff setpoint of 130°F and the rectifier reactivation setpoint of 120°F during the cooldown phase.

It takes approximately 32 hours for the KDZ-501 batteries to charge and an average of 2.5 hours to switch between each batch of batteries. The proposed modification to Inbatec Unit 1 would save Exide Technologies 1,495 charging hours per year. See Appendix C, D, E and F for more information concerning the calculations.

Furthermore, with a total of 80 cells charged per cycle and 16 cells per KDZ-501 battery, the 1,495 hours saved could be used to charge 265 additional batteries every year in Unit 1. At a sale price of \$113 per cell, this increase in battery charging rate will generate an additional \$479,120 per year in revenue.

The proposed modifications to Inbatec Unit 1 would require an investment of approximately \$283 to purchase of equipment. See Appendix E for information concerning this calculation. In-house maintenance labor will be used for installation and an additional \$203 per year will be added to the energy expenses. The ROI for this proposed solution is 98,484%. However, the time

saved and the potential revenue increase by implementing the bypass far outweighs the cost associated with the installation of the bypass and the increase in energy use by the pump.

## Discussion

The investigation from the previous Exide student team concluded the working tower (B01) has the capacity to cool the acid solution to 120°F if a sufficient and constant flow of acid is supplied to the top of the tower. This conclusion was supported by the temperature and valve position data presented in Figure 4.

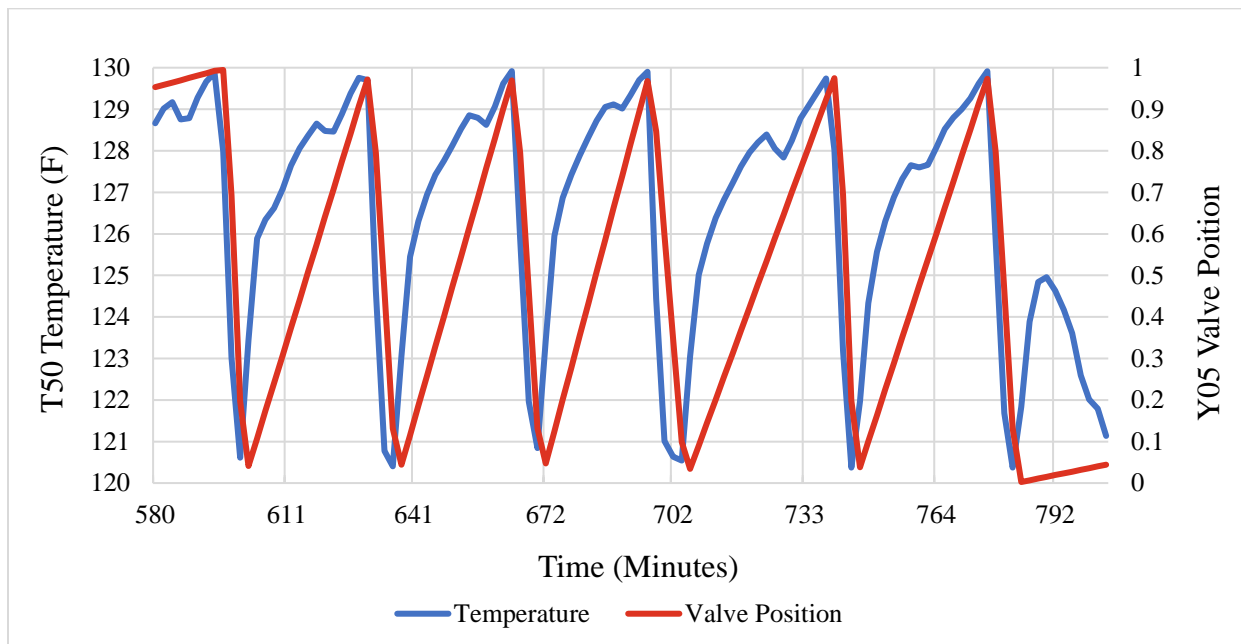

Figure 4. Sample Data of Temperature and Y05 Valve Position over Time

In Figure 4, the temperature of the acid solution quickly drops towards 120°F once Y05 is completely open, and the temperature quickly rises once Y05 has been closed. To maintain the temperature of the acid solution, valve Y05 should be kept in the 100% open position to utilize the cooling capacity of the working tower (B01).

However, the control system imbedded in Inbatec Units 1 and 2 prevent valve Y05 from being kept in the 100% open position. Exide Technologies does not have the capability to alter the control scheme of Y05. With the current control system, Y05 opens in proportion to the temperature above 120°F. When the temperature of the system is at 130°F, Y05 will be completely open. When the temperature of the system is at 120°F, Y05 will be completely closed. The unnecessary oscillations reduce the efficiency of the battery charging process and could damage the pneumatic valve Y05.

In order to prevent the oscillation shown in Figure 4, the pneumatic valve Y05 must be bypassed. The bypass line would provide a constant flow rate of sulfuric acid solution to the top of the

working tower, preventing the acid solution temperature from exceeding 120°F. This bypass would also ensure the rectifier is constantly supplying current, increasing charging efficiency.

## **Conclusions**

The installation of the bypass is a low-cost solution that will greatly increase the battery charging efficiency of Inbatec Units 1. The bypass valve is estimated to decrease annual KDZ battery charging time by 1,495 hours. With the proposed design change made to both Inbatec 1 and 2, Exide Technologies would have the potential to produce approximately 530 additional KDZ-501 per year, equivalent to approximately \$958,240 in additional revenue.

## **Recommendations**

Since the flowrate of the sulfuric acid solution needed the top of the work tank depends on the ambient air temperature, it is recommended that steady state temperature readings of T50 should be measured at various flowrates throughout the year. Once a steady state acid solution temperature of 115°F is able to be maintained year round, it is recommended that Exide Technologies coordinate with the makers of the Inbatec system to make more permanent modifications to the control scheme of Y05 on all the Inbatec Units.

# Appendix

## Appendix A: Pump Curve

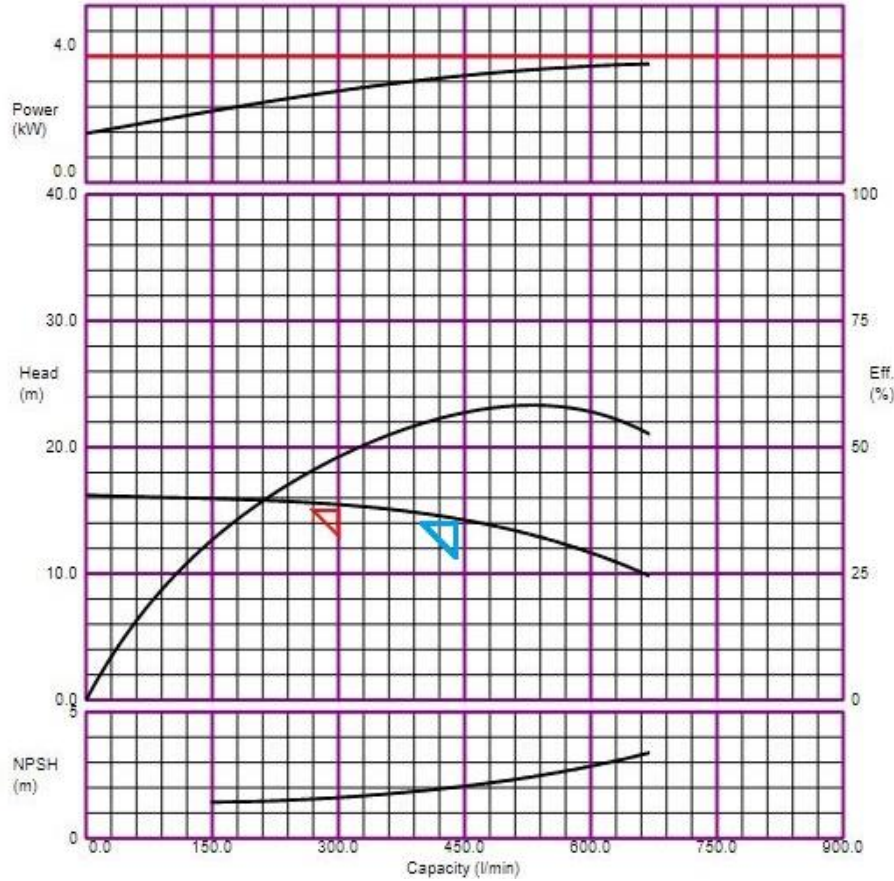

## ASSOMA-SCAC

### Performance Data

<b>Pump</b> Model : AMX-655FESSV Pump Head : 15.48 m Power : 2.90 kW Eff. : 48.09 % NPSHr : 1.61 m Motor Output : 4.00 kW Min. Flow : 40.00 l/min
<b>Duty Point</b> Capacity : 300 l/min Resistance : 15.00 m NPSHa : m
<b>Liquid</b> Name : Sulfuric Acid, 96% Temp : 25.00 °C Sp. Gr. : 1.84 Viscosity : 20.63 cP Vap. Pressure : 0.00 kPa

At the current recommended flowrate (300 L/min, indicated by the red triangle), there is 15.48 meters of head loss for this pump model. At the proposed maximum flowrate (440 L/min, indicated by the blue triangle), there is approximately 14 meters of head loss.

## Appendix B: Method for Determining the Head Loss from the Proposed Modification

To calculate the head loss of the proposed bypass line, the following equation was used.

$$h_L = K_L V^2 / (2g)$$

Where  $K_L$  is the total loss coefficient,  $V$  is the average velocity in the pipe, and  $g$  is the acceleration of gravity ( $9.81 \text{ m/s}^2$ ).

Volumetric Flow Rate (L/min)	Fluid Velocity (m/s)	Loss Coefficient (K)			Head Loss (Meters)
		$K_{\text{Elbow}}$	$K_{\text{Valve}}$	$K_{\text{Total}}$	
200	7.689	0.9	0.05	1.85	5.57
175	6.728	0.9	0.05	1.85	4.27
150	5.767	0.9	0.05	1.85	3.14
125	4.806	0.9	0.05	1.85	2.18
100	3.845	0.9	0.05	1.85	1.39
75	2.883	0.9	0.05	1.85	0.78
50	1.922	0.9	0.05	1.85	0.35

The minor head loss in the pipeline due to increased flow rate is calculated by using the following Moody Diagram.

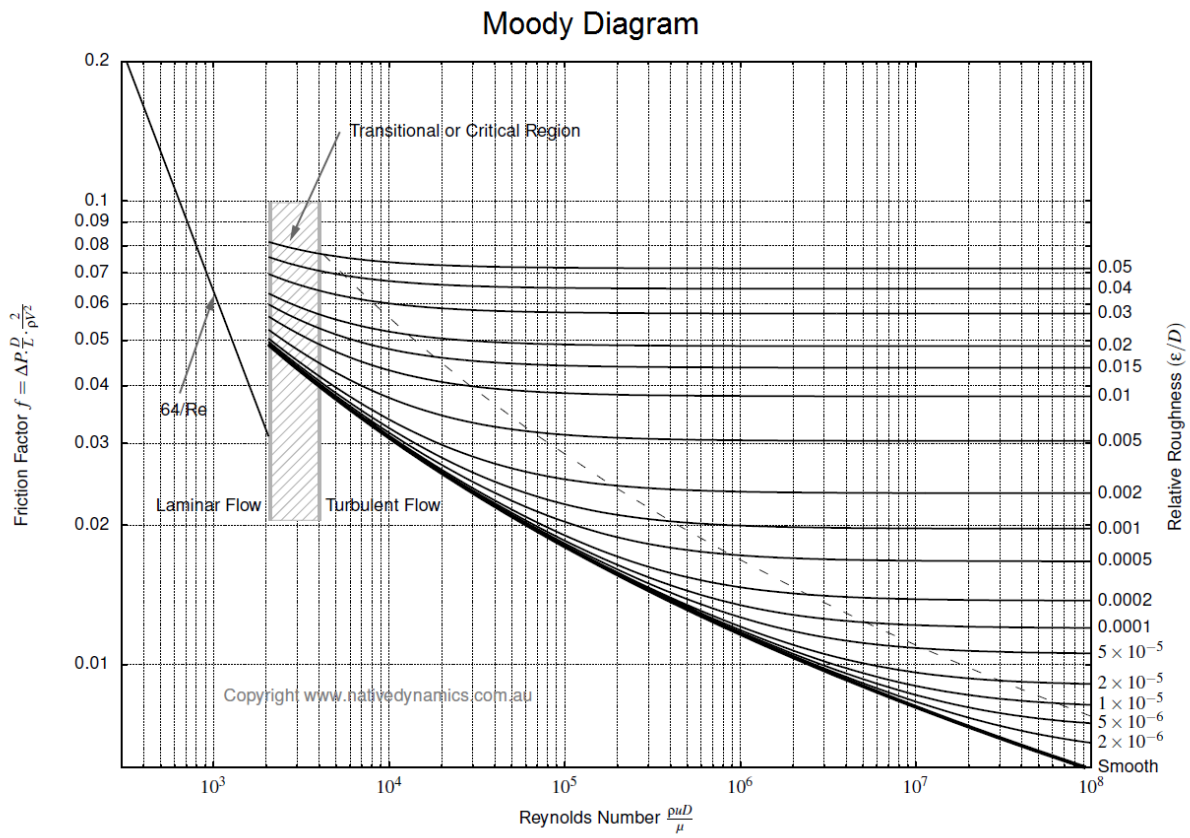

### Appendix C: Method for Determining Time Saved for Unit 1

Assumptions:

- The rectifier is off for the duration of time when T50 decreases from 130°F to 120°F.
- Total run time per profile: 31.82 hours
- Time between charging profiles: 2.5 hours
- The average time that the rectifier is off for any day of the year is the average of the two days analyzed. Assumption made after researching the temperatures in Fort Smith on the days analyzed and the average temperature of Fort Smith, AR.

	Session Time Analyzed (minutes)	Session Time Rectifier Off (minutes)	Full Charge Time Rectifier Off (minutes)	New Full Charge Cycle Time (hours)
July 2019	640	296	562	25.0
December 2019	640	108	173	31.4

$(350 \text{ days/year}) (24 \text{ hours/day}) (34.3 \text{ hours/cycle}) = \text{old system cycles/year} = 245 \text{ cycles/year}$

$[(25.0 \text{ hours/cycle}) + (31.4 \text{ hours/cycle})] / 2 = \text{hours/cycle on average} = 28.2 \text{ hours/cycle}$

$(350 \text{ days/year}) (24 \text{ hours/day}) (28.2 \text{ hours/cycle}) = \text{new system cycles/year} = 298 \text{ cycles/year}$

$(298 \text{ cycles/year}) - (245 \text{ cycles/year}) = \text{additional cycles/year} = 53 \text{ cycles/year}$

$(53 \text{ cycles/year}) (28.2 \text{ hours/cycle}) = \text{charging hours saved /year} = 1495 \text{ hours/year}$

### Appendix D: Method for Determining Additional Revenue for Unit 1

Assumptions:

- \$113 per cell
- 16 cells in one brick
- Inbatec 1 charges 80 cells/cycle

$(53 \text{ cycles/year}) (80 \text{ cells/cycle}) = \text{additional cells/year} = 4240 \text{ cells/year}$

$(4240 \text{ cells/year}) (\$113/\text{cell}) = \text{additional revenue/year} = \$479,120/\text{year}$

Note: 53 cycles/year

## Appendix E: Method for Determining Additional Energy Expenses

Assumptions:

- 0.5kW increase in pump power requirement
- 0.0482 \$/kWh

(298 cycles/year) (28.2 hours/cycle) = total pump operating hours = 8403.6 hours/year

(8403.6 hours/year) (0.5kW) = 4201.2 kWh/year

(4201.2 kWh/year) (0.0482 \$/kWh) = \$202.5/year

## Appendix F: Cost of Bypass Line Implementation

Item	Unit Price	Quantity	Final Price
32 mm Polyethylene Piping	\$11.57/meter	2 meters	\$29.30
32mm Elbows Fittings	\$2.97	2	\$5.94
32mm Manual Diaphragm Valve	\$238.98	1	\$238.98
32mm Tee Fittings	\$4.41	2	\$8.82
Labor	In-House	2 hours	\$0.00
		<b>Total Cost:</b>	<b>\$283.04</b>



## References

1. City Irrigation Ltd - The one stop shop for all your Irrigation and Water Pipe fittings. (n.d.). Retrieved from <https://cityirrigation.co.uk/>
2. Direct Industry – The online industrial exhibition. Retrieved from <https://www.directindustry.com/>

## **Personal Contribution: Reagan Gilker**

Dr. Ackerson,

At the beginning of the semester, I volunteered to be the team leader for the Spring 2020 Student Exide Team. I was willing to put in the work that was expected of the team leader. I believe my contributions to the team are enough to be in good standing with my honors thesis. A comprehensive list of my contribution to the team is as follows,

- Led team meetings
- Prepared and organized notes from team meetings
- Organized the Microsoft Teams Folder
- Booked rooms for team meetings
- Delegated tasks/action items to team members
- Ensured team members completed assigned tasks
- Assisted in the creation of the Aspen Model
- Edited PFD of process
- Created Figure 2 of the final report
- Proofread and edited each draft of the final report

If you have any questions, do not hesitate to reach out to me.

Best,  
Reagan Gilker  
regilker@uark.edu  
010711473